

REED MILL & LUMBER CO., INC.

1 X 4 STOCK PATTERNS

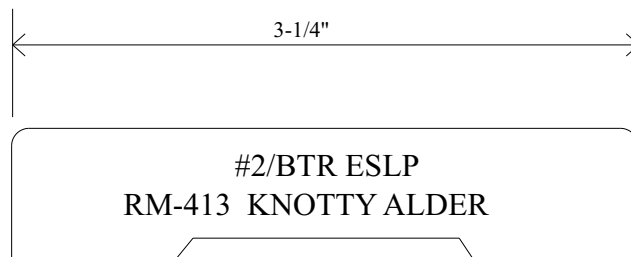
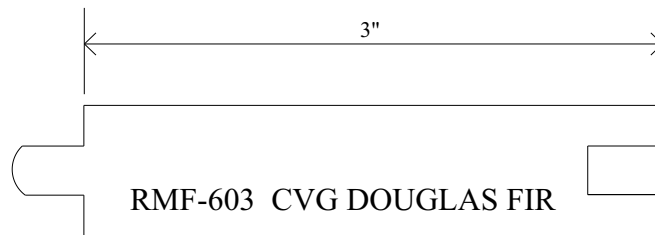
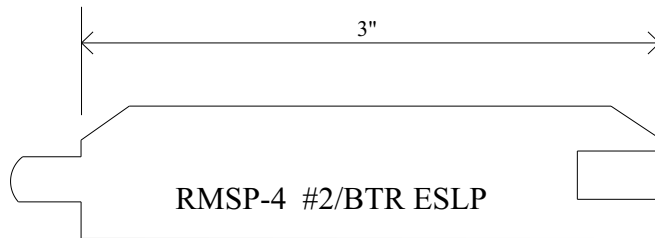
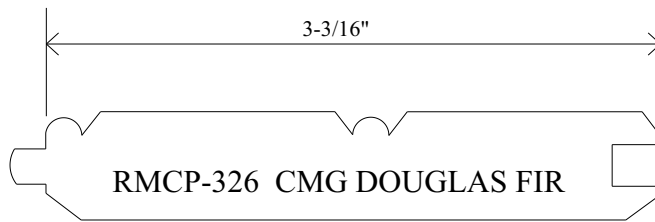
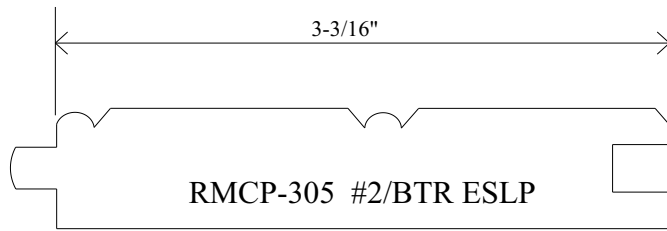

REED MILL & LUMBER CO., INC.

1 X 6 STOCK PATTERNS

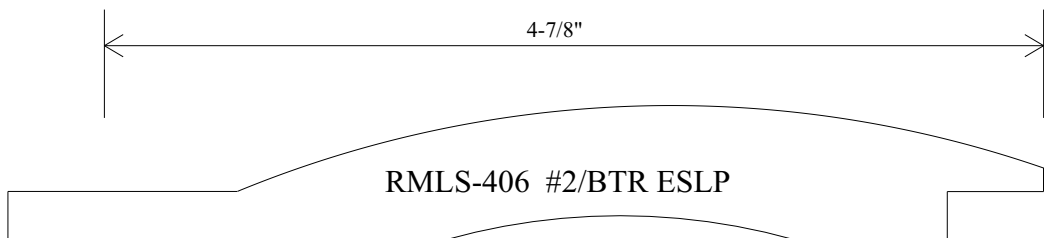
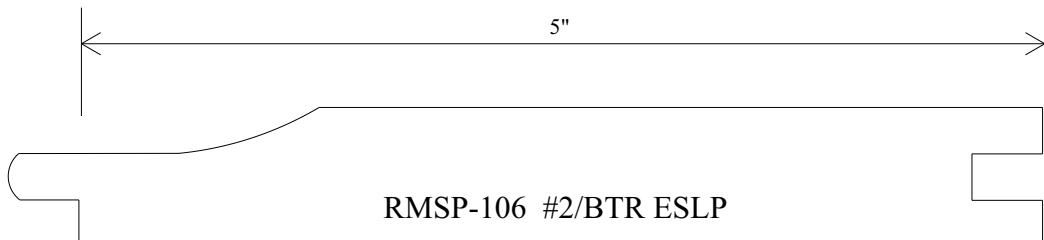
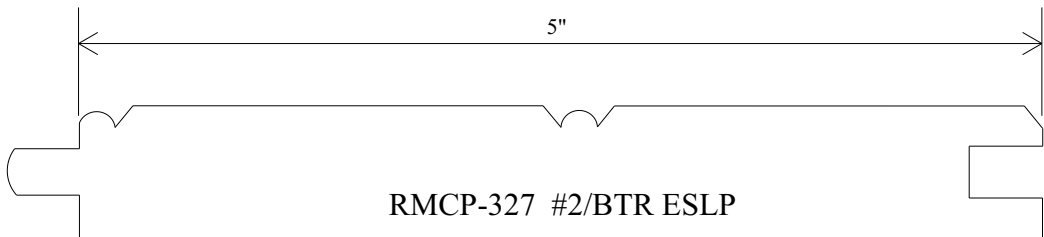
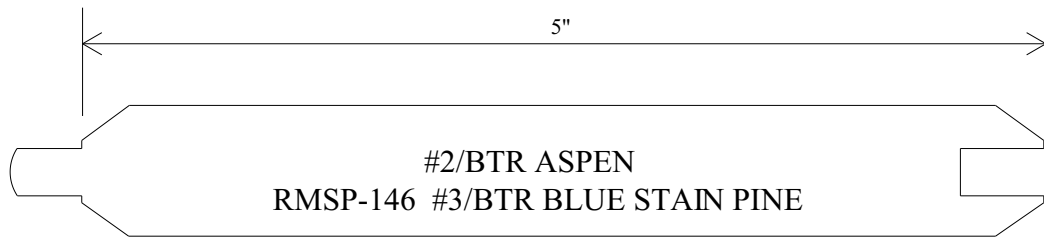
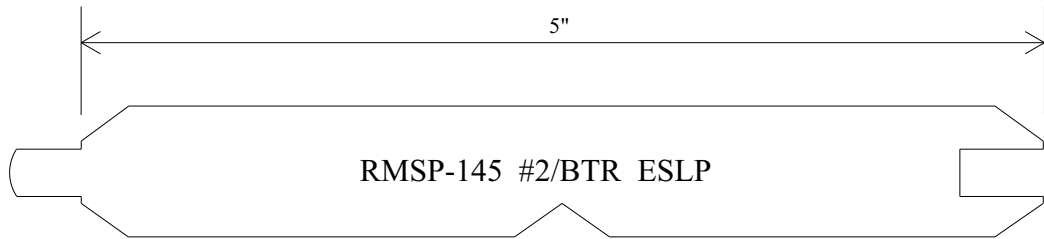

REED MILL & LUMBER CO., INC.

1 X 6 STOCK PATTERNS

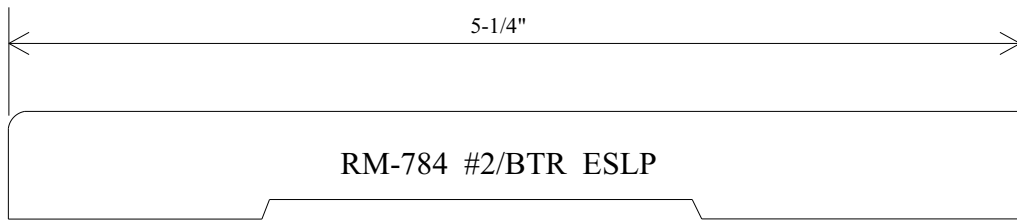
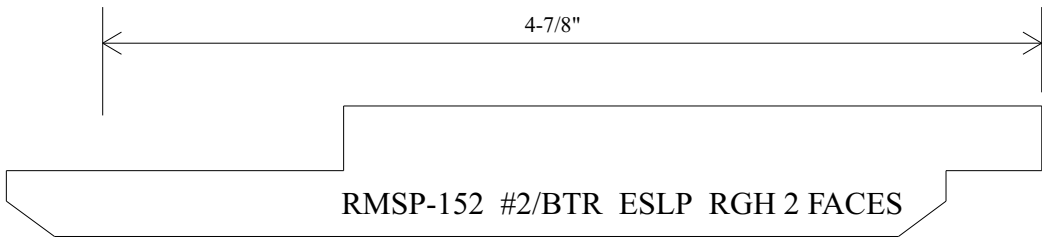

REED MILL & LUMBER CO., INC.

1 X 8 STOCK PATTERNS

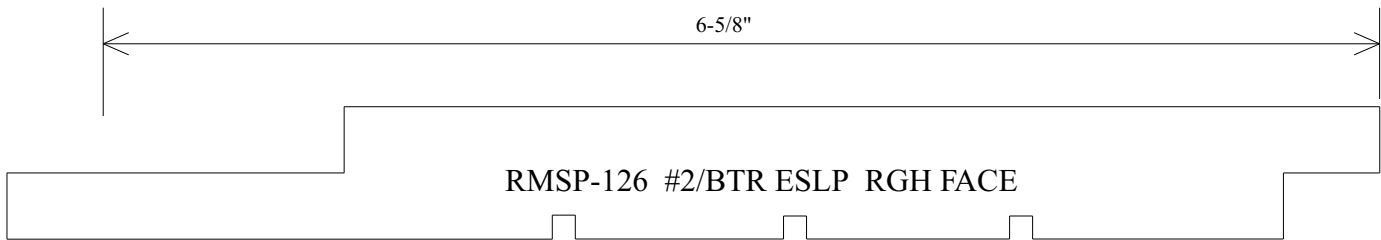
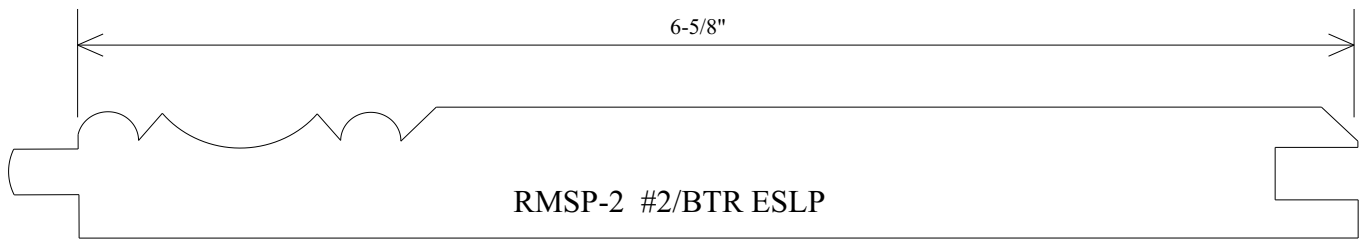

REED MILL & LUMBER CO., INC.

2 X 6 STOCK PATTERNS

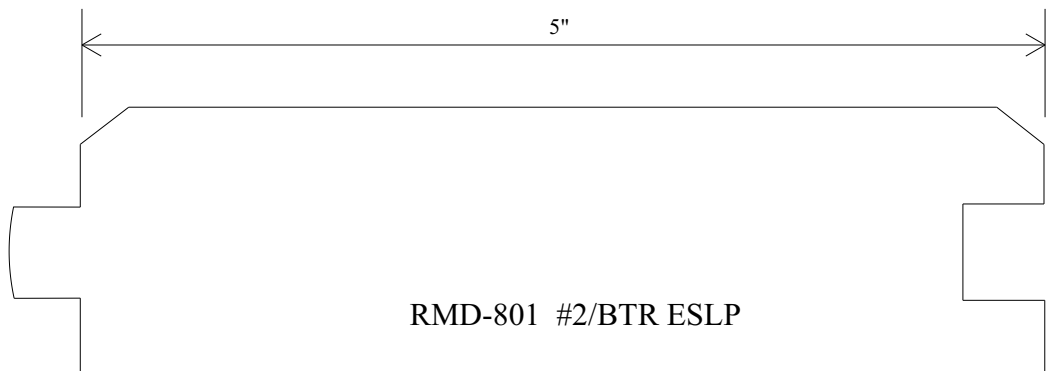
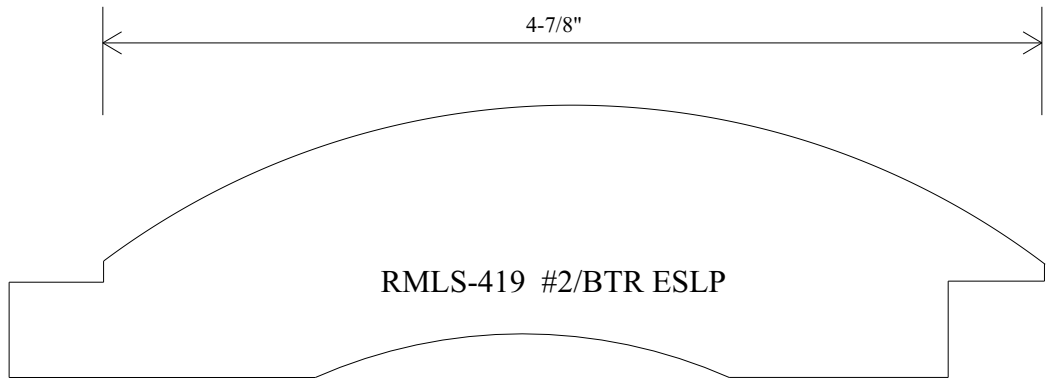
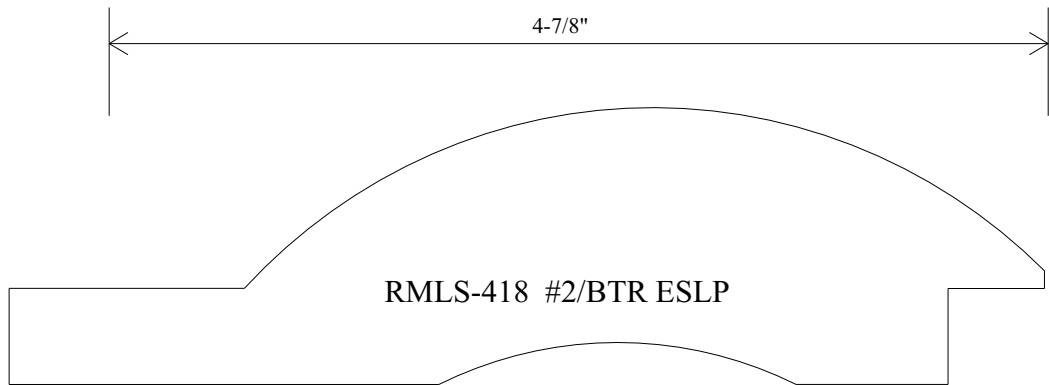

REED MILL & LUMBER CO., INC.

2 X 8 STOCK PATTERNS

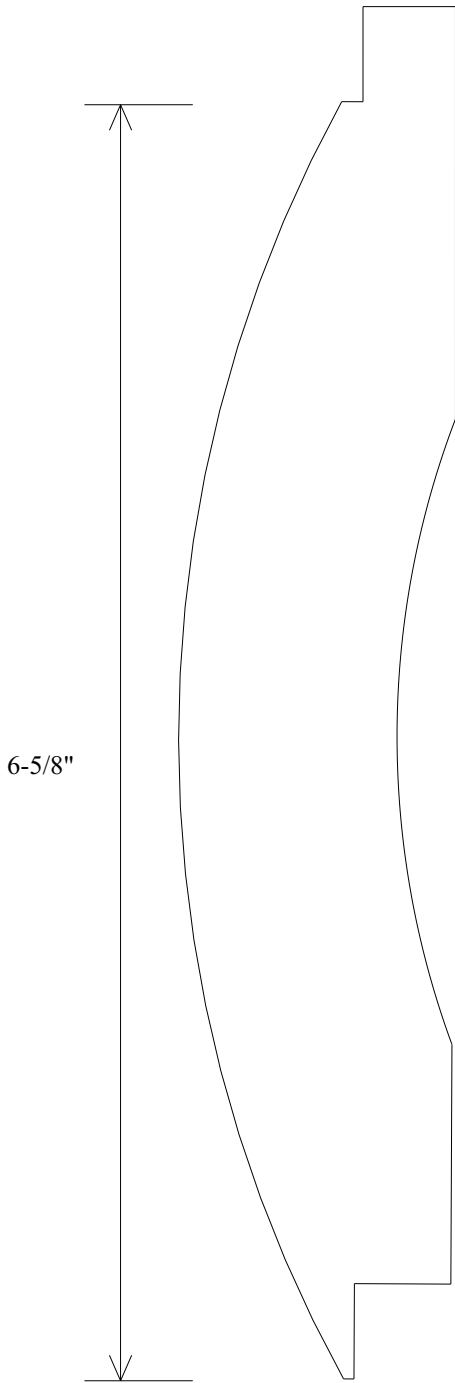

RMLS-441 #2/BTR ESLP

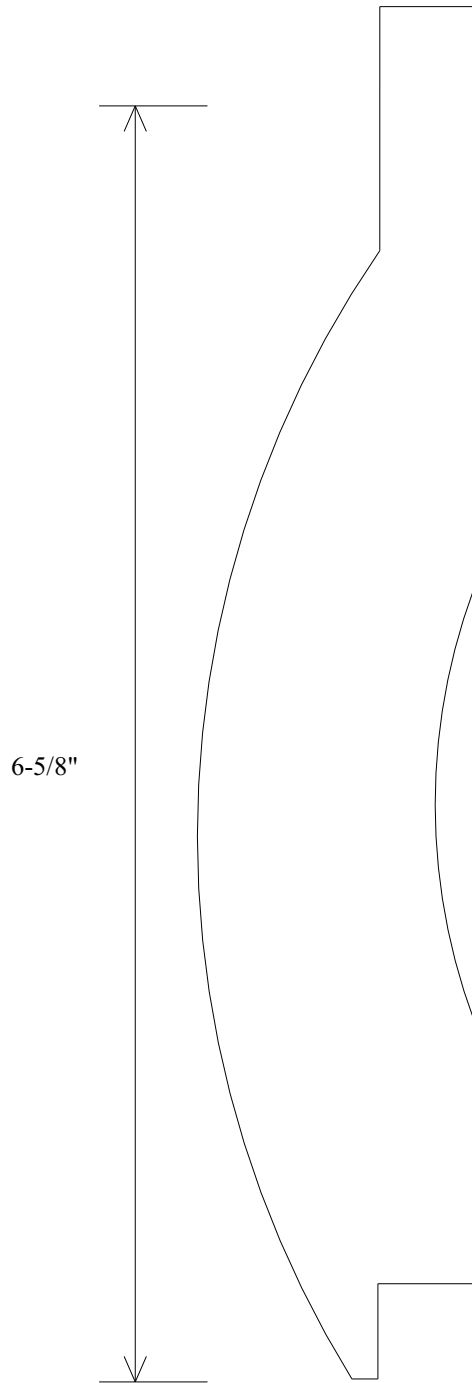

RMLS-442 #2/BTR ESLP

REED MILL & LUMBER CO., INC.

LOG CORNERS

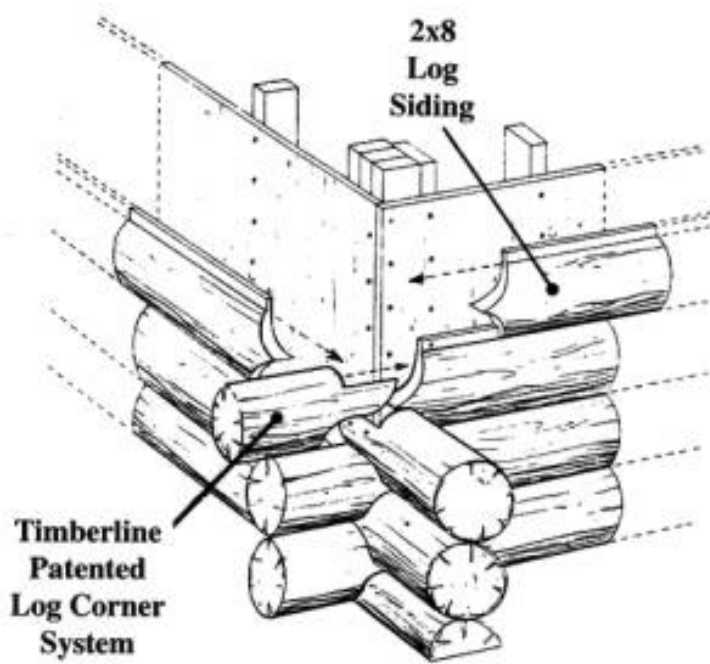

REED MILL & LUMBER CO., INC.

OTHER STOCK PATTERNS

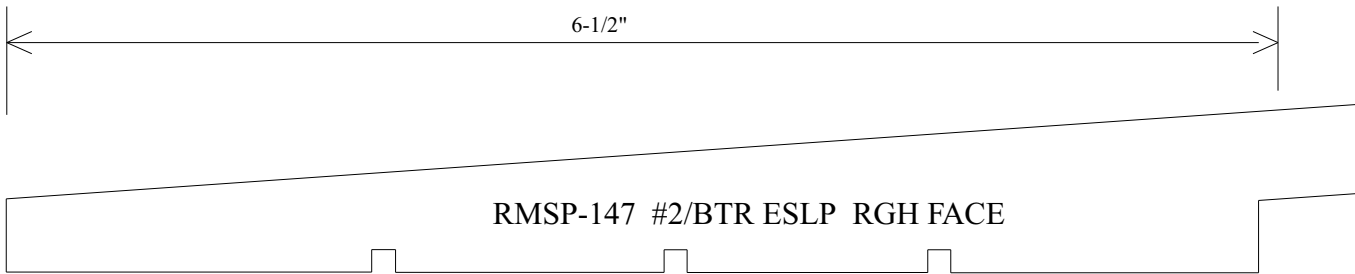
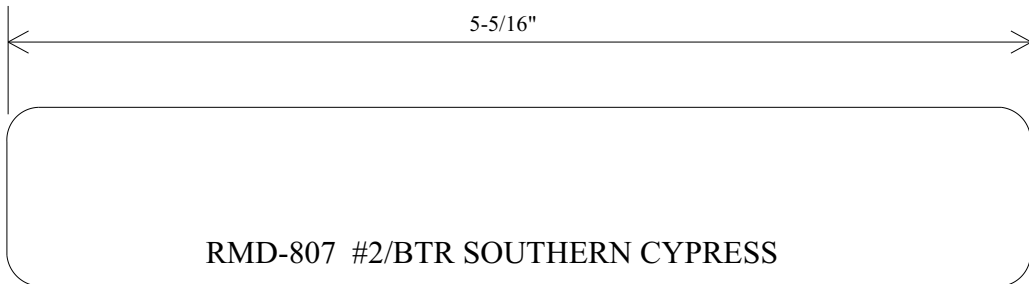
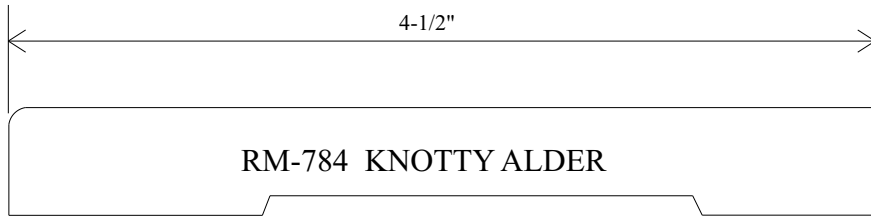

REED MILL & LUMBER CO., INC.

STOCK BOARDS



1 X 4

PINE/ESLP	DOUGLAS FIR	ALDER
C/BTR	CVG	KNOTTY
D/BTR	CMG	
#2/BTR		
#3/BTR		

1 X 5

SOUTHERN YELLOW PINE
D/BTR

1 X 6

PINE/ESLP	DOUGLAS FIR	ALDER
C/BTR	CVG	KNOTTY
D/BTR	CMG	
#2/BTR	#2/BTR	
#3/BTR		

1 X 8

PINE/ESLP	DOUGLAS FIR
C/BTR	CVG
D/BTR	CMG
#2/BTR	#2/BTR
#3/BTR	

1 X 10

PINE/ESLP	DOUGLAS FIR
C/BTR	CVG
D/BTR	CMG
#2/BTR	
#3/BTR	

1 X 12

PINE/ESLP	DOUGLAS FIR
C/BTR	CVG
D/BTR	CMG
#2/BTR	
#3/BTR	

REED MILL & LUMBER CO., INC.

STOCK BOARDS

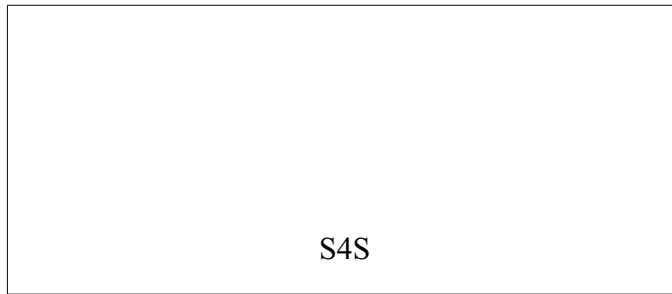

2 X 4

DOUGLAS FIR
CVG
CMG

2 X 6

PINE/ESLP
D/BTR
#2/BTR

DOUGLAS FIR
CVG
CMG
#1/BTR

CEDAR
#2/BTR

2 X 8

PINE/ESLP
#2/BTR

DOUGLAS FIR
CVG
CMG

CEDAR
#2/BTR

2 X 10

PINE/ESLP
#2/BTR

DOUGLAS FIR
CVG
CMG

2 X 12

PINE/ESLP
#2/BTR

DOUGLAS FIR
CVG
CMG

REED MILL & LUMBER CO., INC.

STOCK BOARDS



1 X 4

SPRUCE
#2

CEDAR
A/BTR
D/BTR

1 X 6

SPRUCE
#2

CEDAR
A/BTR
D/BTR
#3/BTR

1 X 8

SPRUCE
#2

CEDAR
A/BTR
D/BTR
#3/BTR

1 X 10

SPRUCE
#2

CEDAR
A/BTR
D/BTR
#3/BTR

1 X 12

SPRUCE
#2

CEDAR
#3/BTR

REED MILL & LUMBER CO., INC.

STOCK BOARDS



2 X 4

SPRUCE
#2 RAW
PRIMED

2 X 6

SPRUCE
#2 RAW
PRIMED

2 X 8

PINE/ESLP
#2 RAW
PRIMED

2 X 10

PINE/ESLP
#2 RAW
PRIMED

2 X 12

PINE/ESLP
#2 RAW
PRIMED

REED MILL & LUMBER CO., INC.

OTHER STOCK ITEMS AND SERVICES

2 X 2 S4S PRIMED

4 X 4 - 6 X 6 - 8 X 8 PRIMED POSTS

5/4 X 12 BULLNOSE STEPPING CVG DOUGLAS FIR

12" 16" & 24" BULL NOSE SHELVING MDF

3/4" 4 X 8 SHEETS MDF

CUSTOM MILLING AND MILLWORK

REED MILL & LUMBER CO., INC.

SIDING AND PANELING

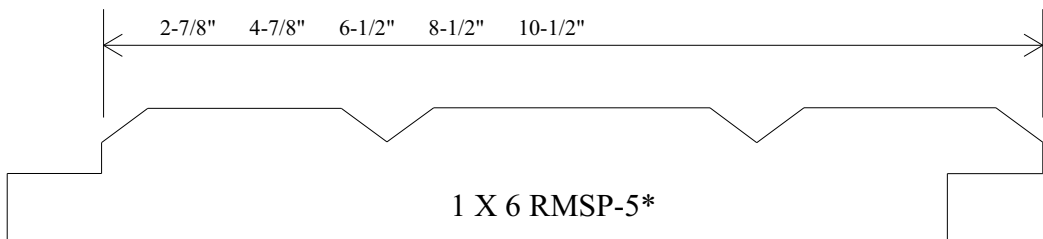
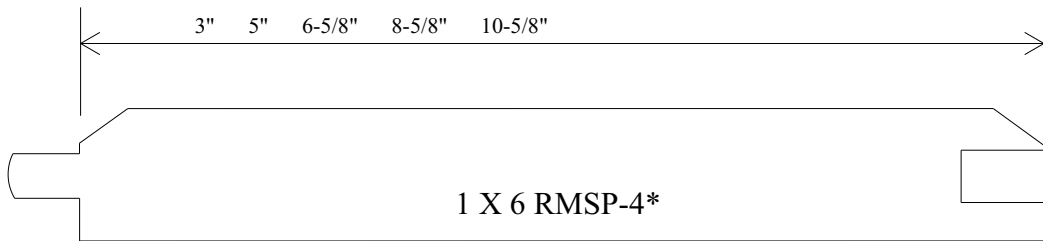
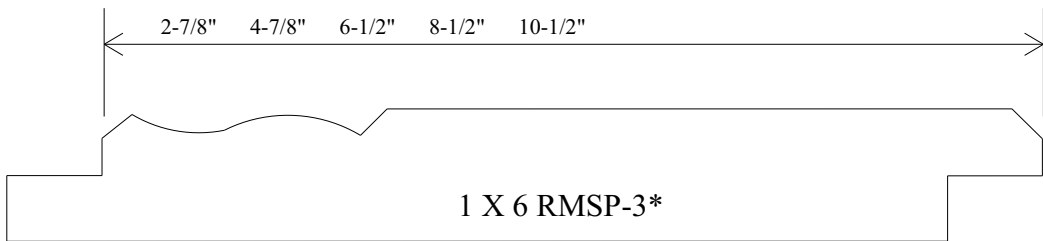
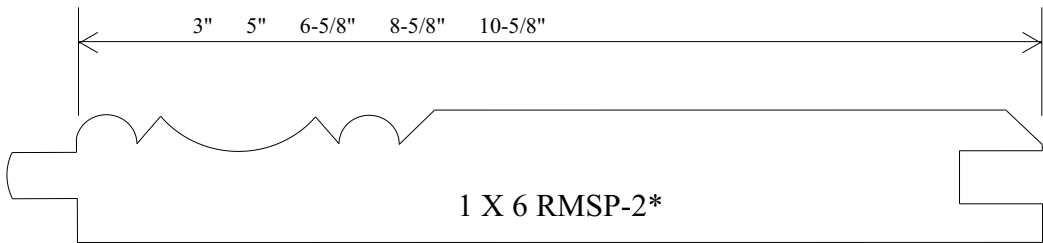
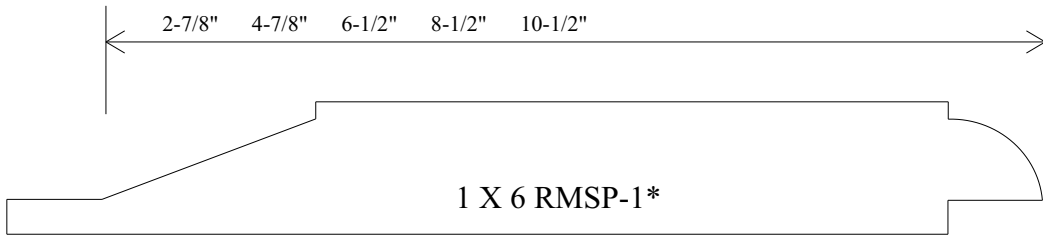

* MATCHES OR SIMILAR TO WWPA STANDARD PATTERNS

PG. SP 1

REED MILL & LUMBER CO., INC.

SIDING AND PANELING

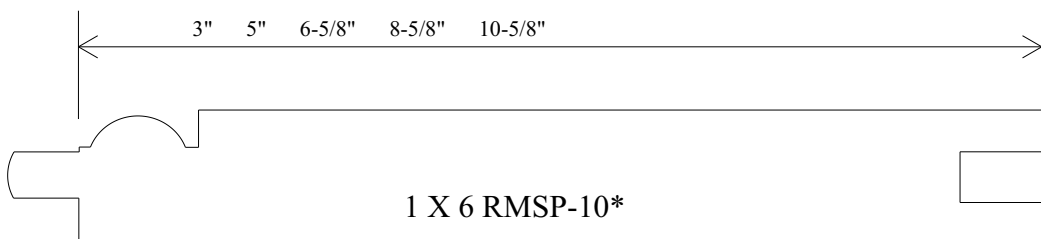
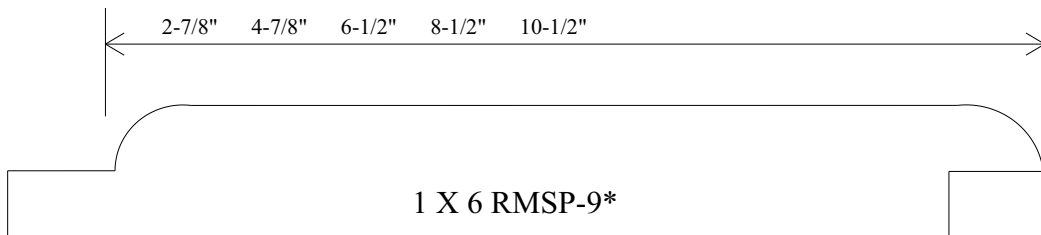
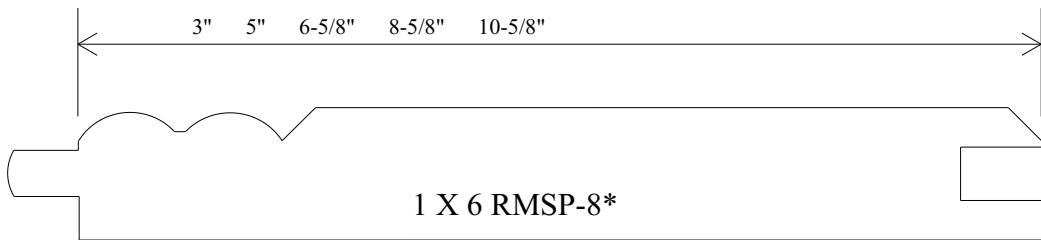
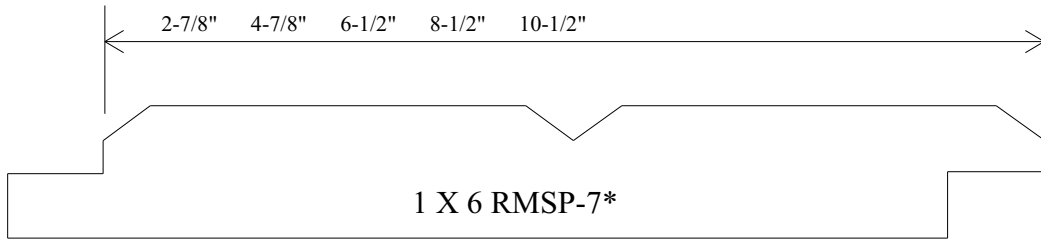
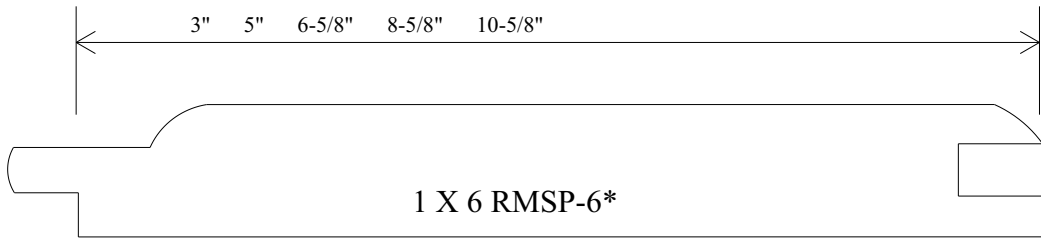

* MATCHES OR SIMILAR TO WWPA STANDARD PATTERNS

PG. SP 2

REED MILL & LUMBER CO., INC.

SIDING AND PANELING

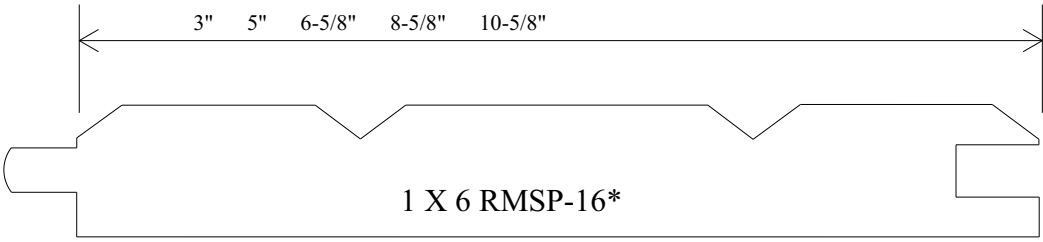
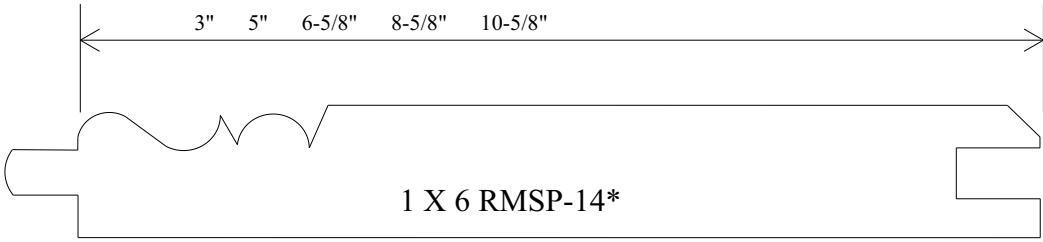
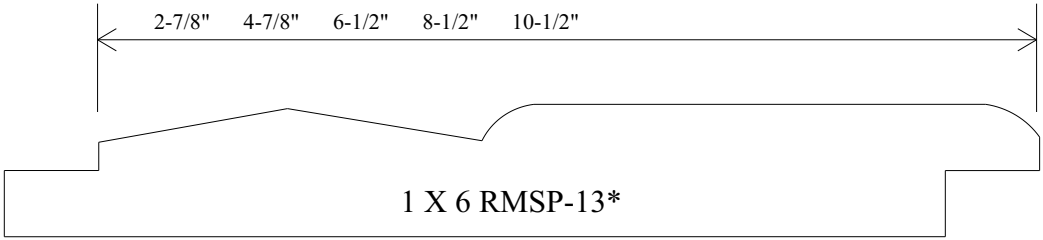
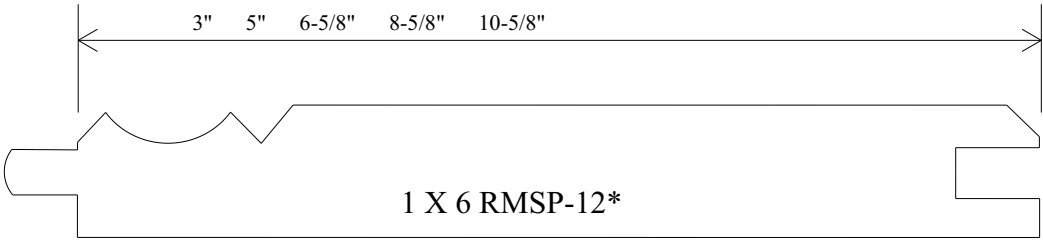
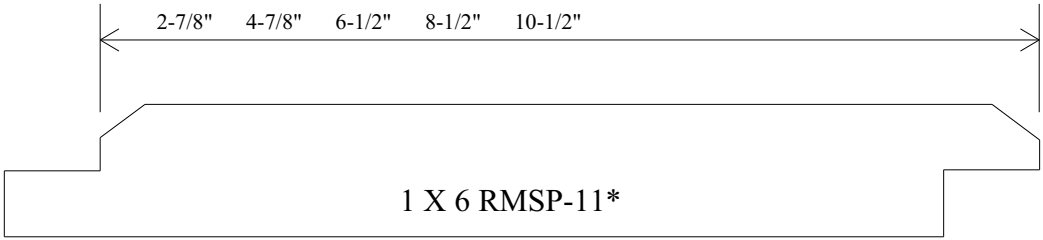

* MATCHES OR SIMILAR TO WWPA STANDARD PATTERNS

REED MILL & LUMBER CO., INC.

SIDING AND PANELING

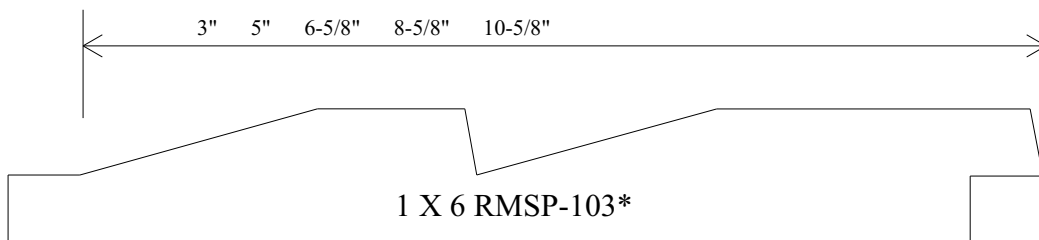
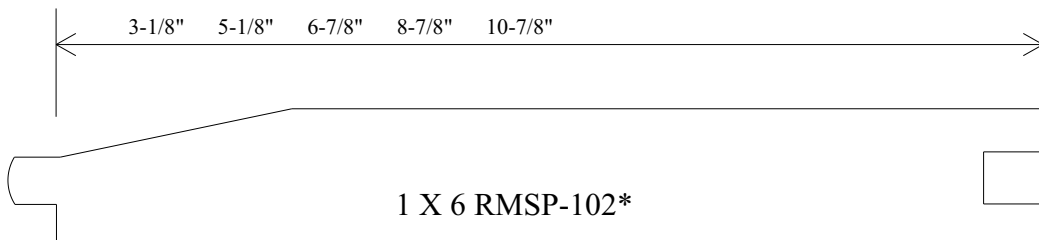
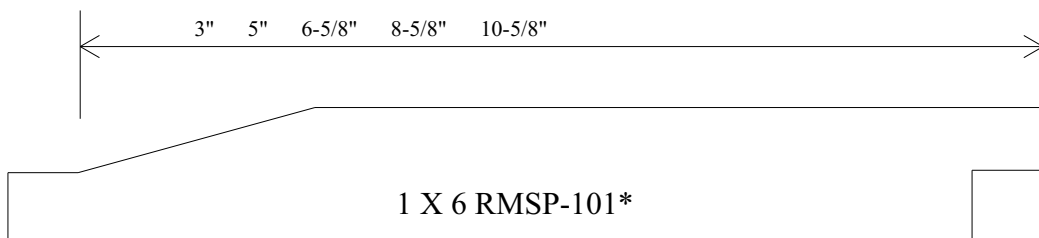
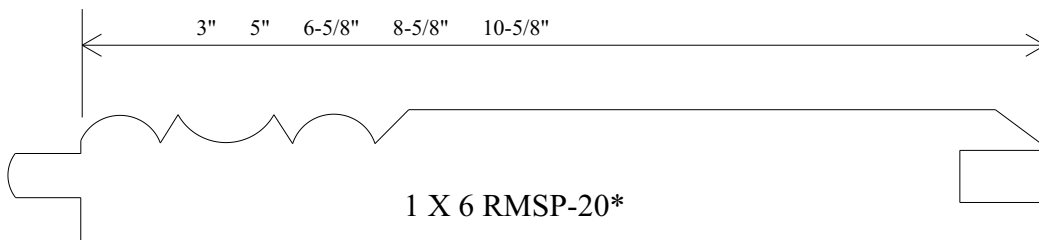
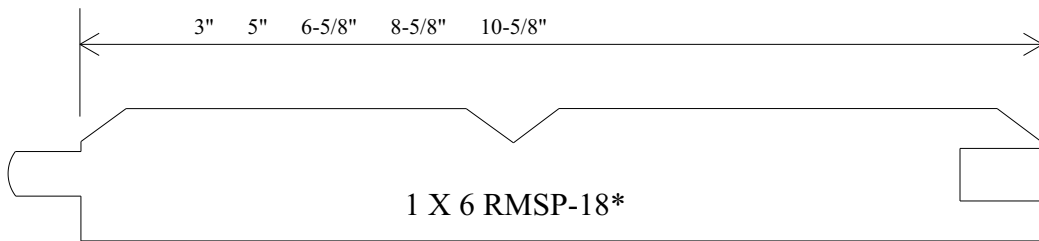

REED MILL & LUMBER CO., INC.

SIDING AND PANELING

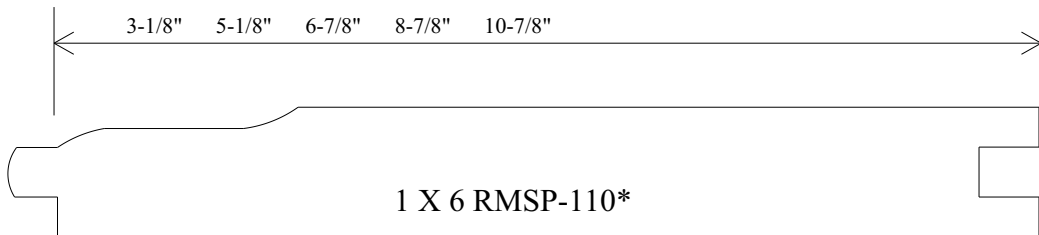
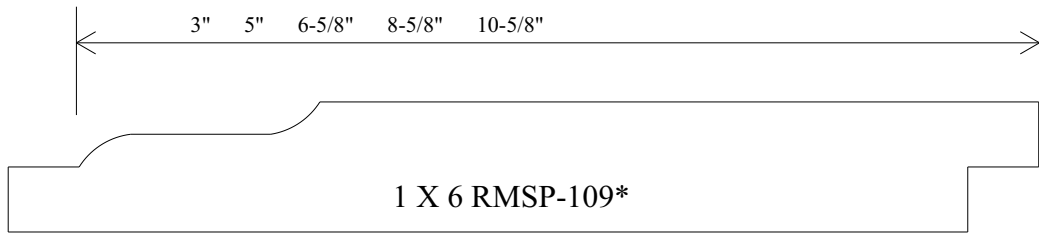
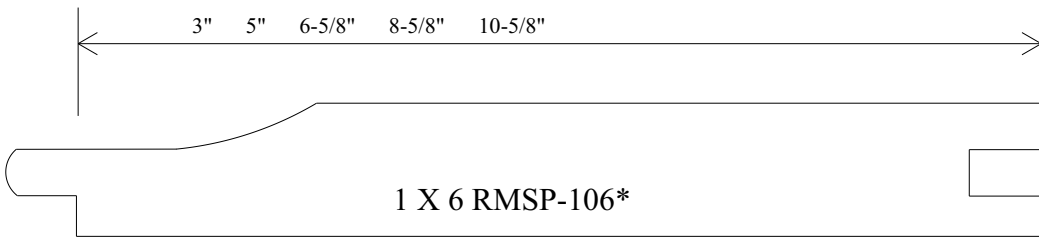
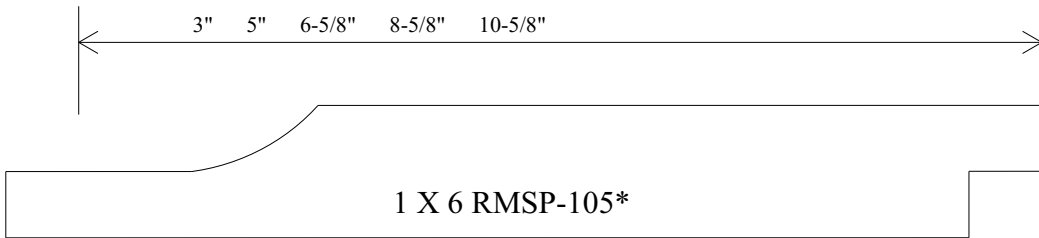
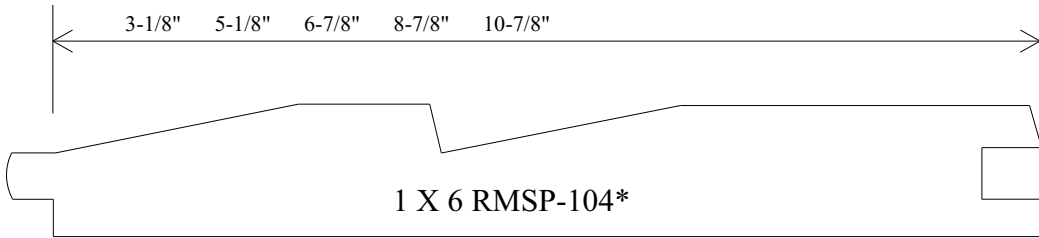

* MATCHES OR SIMILAR TO WWPA STANDARD PATTERNS

REED MILL & LUMBER CO., INC.

SIDING AND PANELING

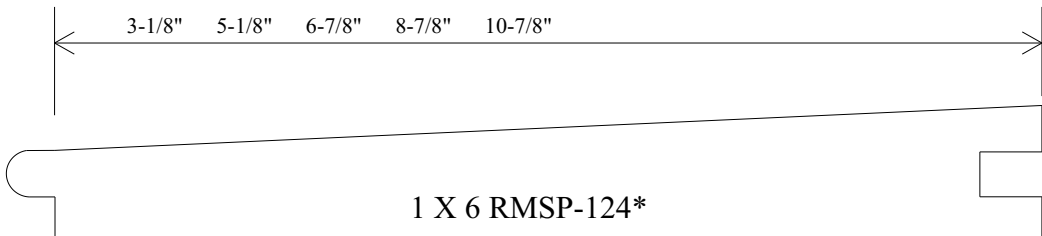
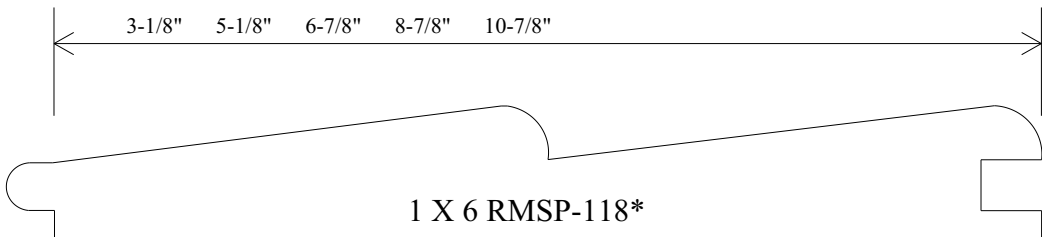
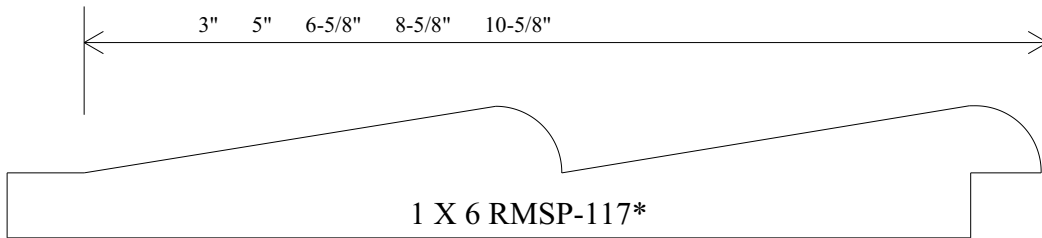
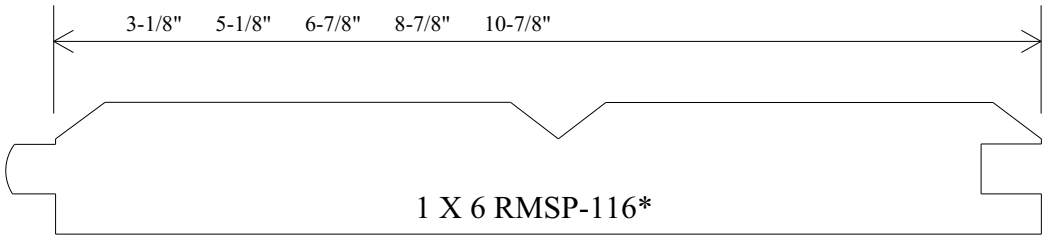
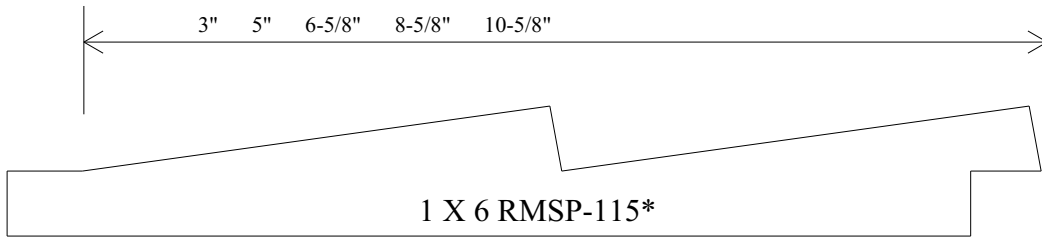

REED MILL & LUMBER CO., INC.

SIDING AND PANELING

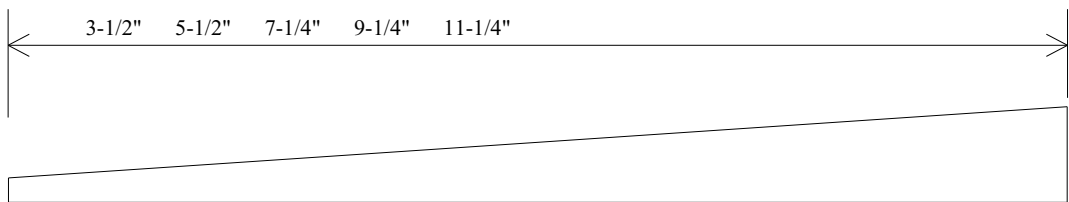
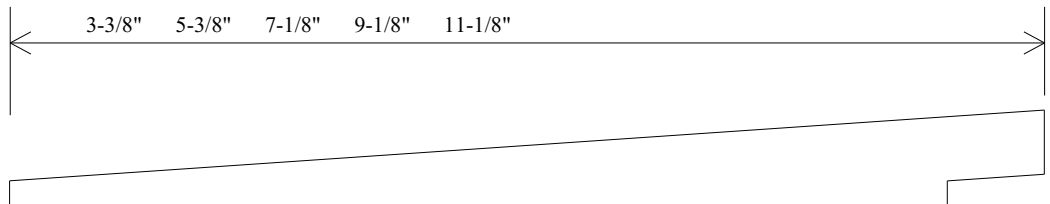
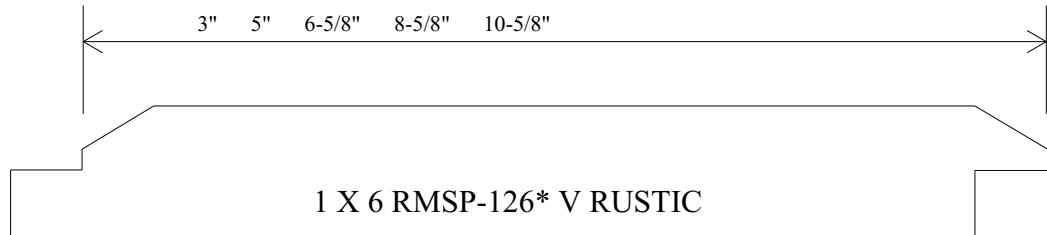
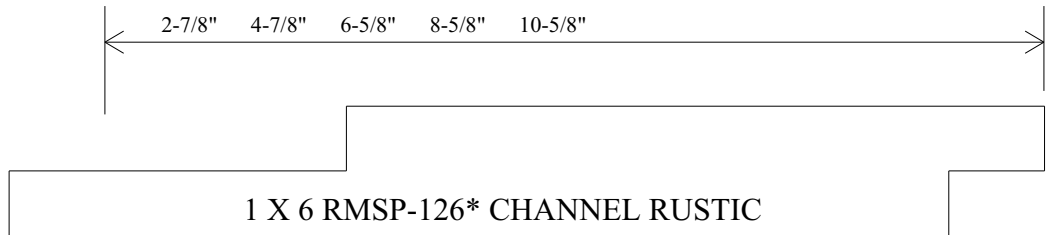
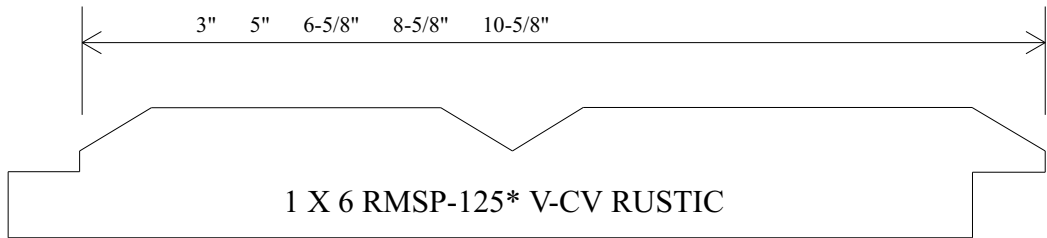

REED MILL & LUMBER CO., INC.

SIDING AND PANELING

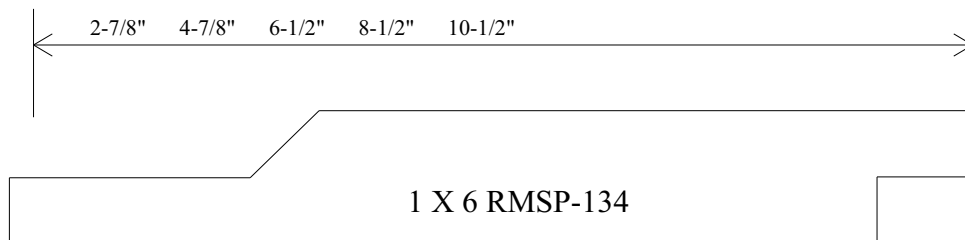
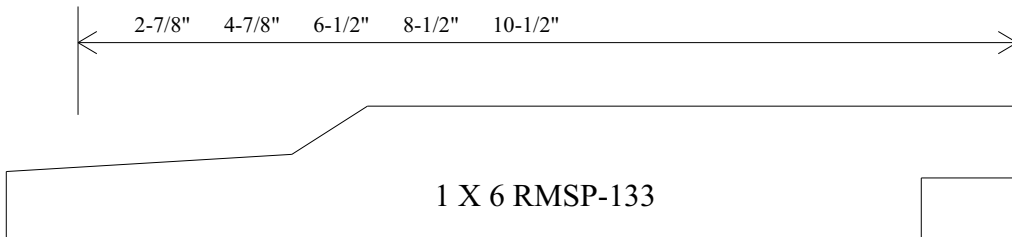
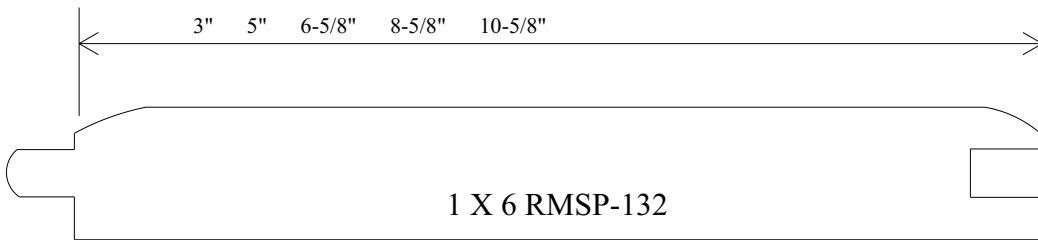
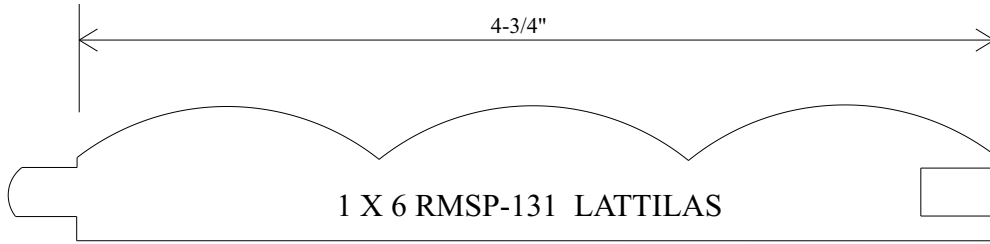
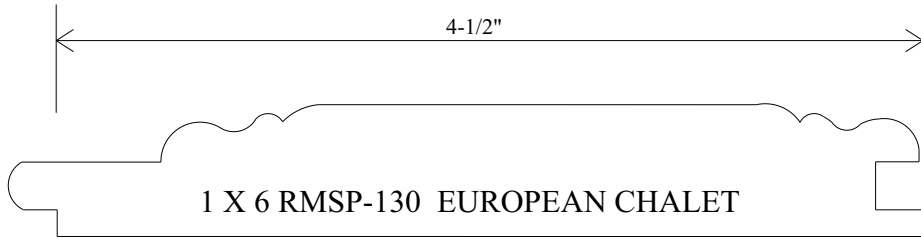

REED MILL & LUMBER CO., INC.

SIDING AND PANELING

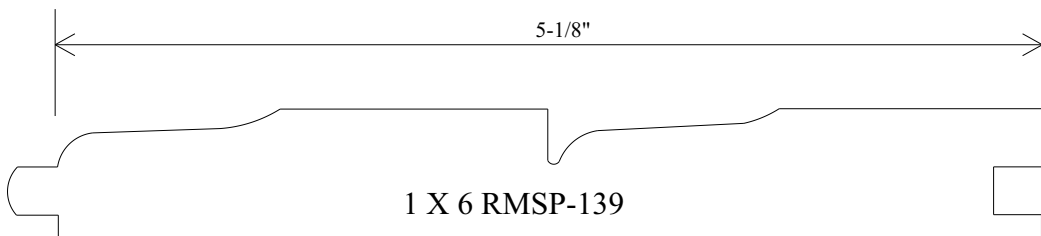
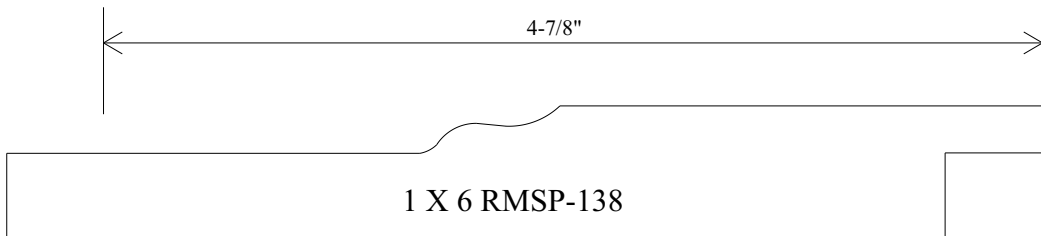
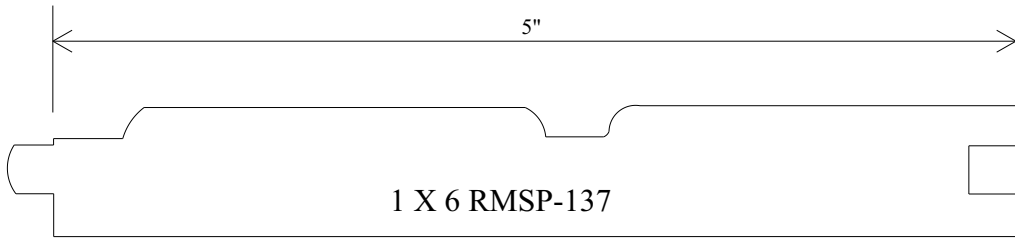
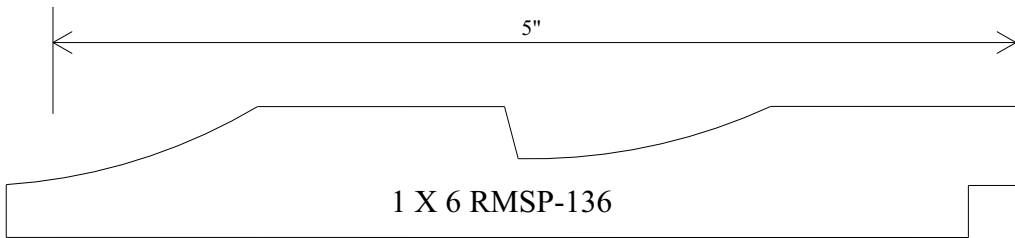
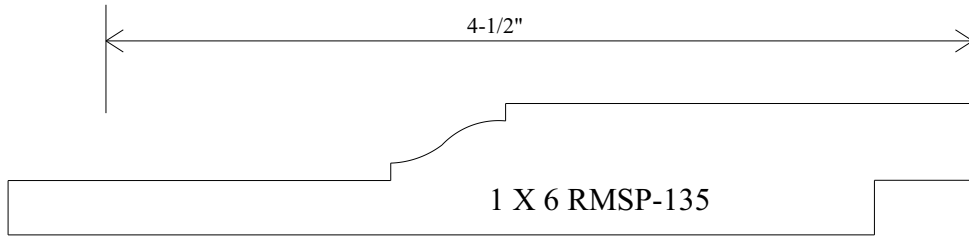

REED MILL & LUMBER CO., INC.

SIDING AND PANELING

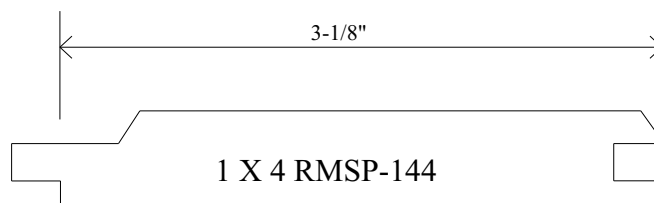
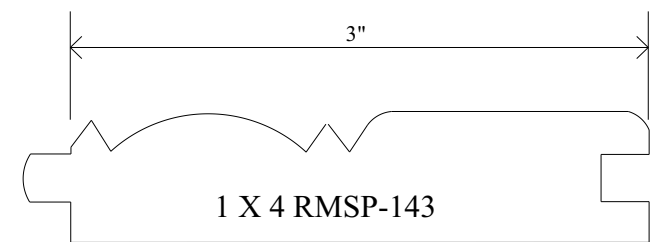
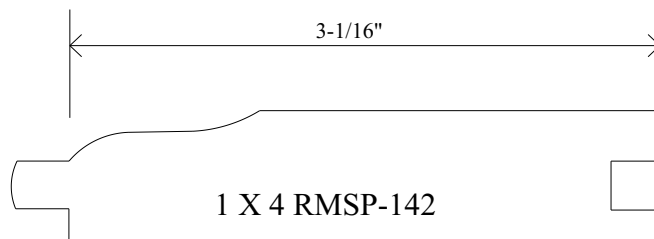
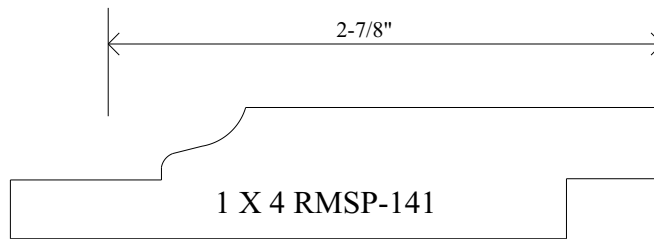
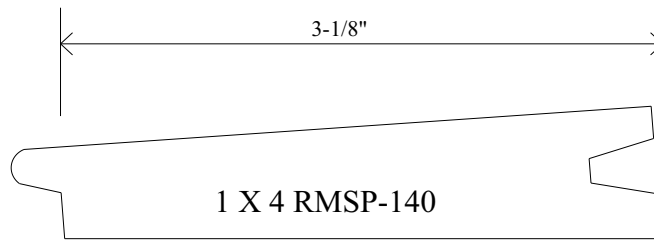

REED MILL & LUMBER CO., INC.

SIDING AND PANELING

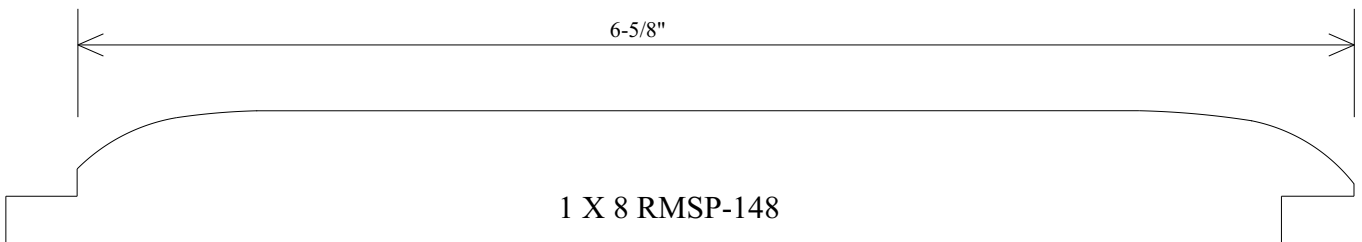
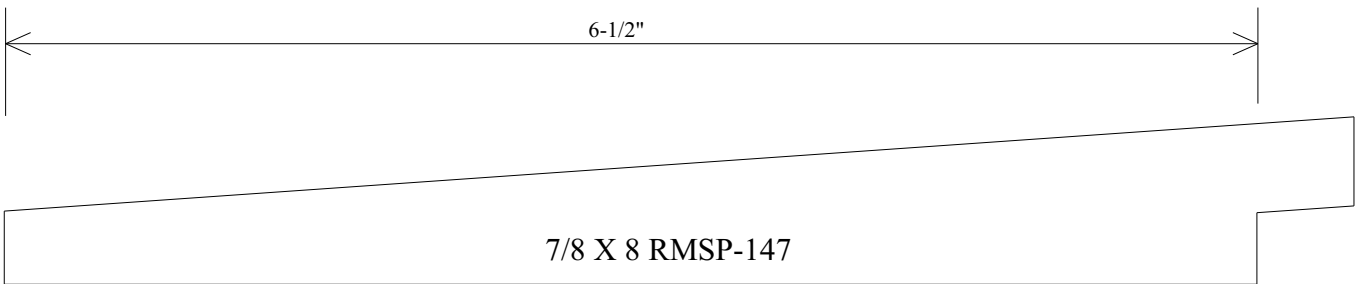
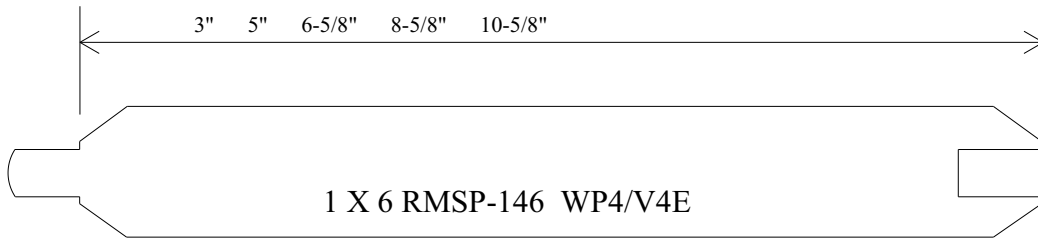
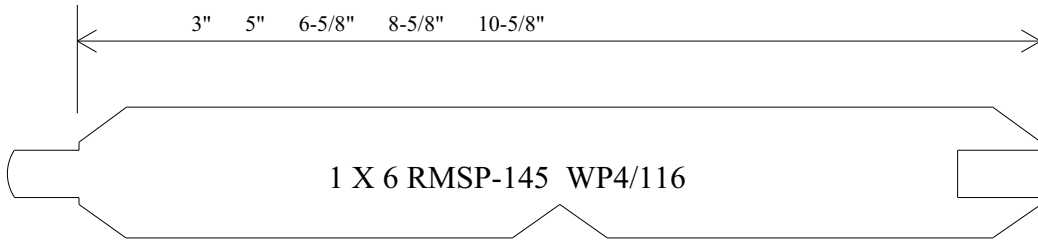

REED MILL & LUMBER CO., INC.

SIDING AND PANELING

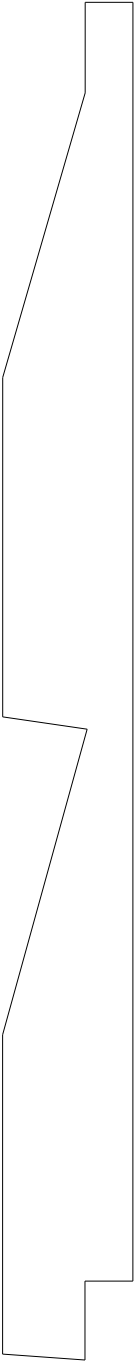

1 X 8 RMSP-149
FACE 6-5/8"

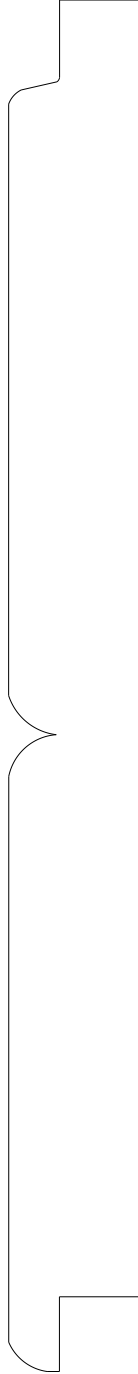

1 X 8 RMSP-150
FACE 6-3/4"

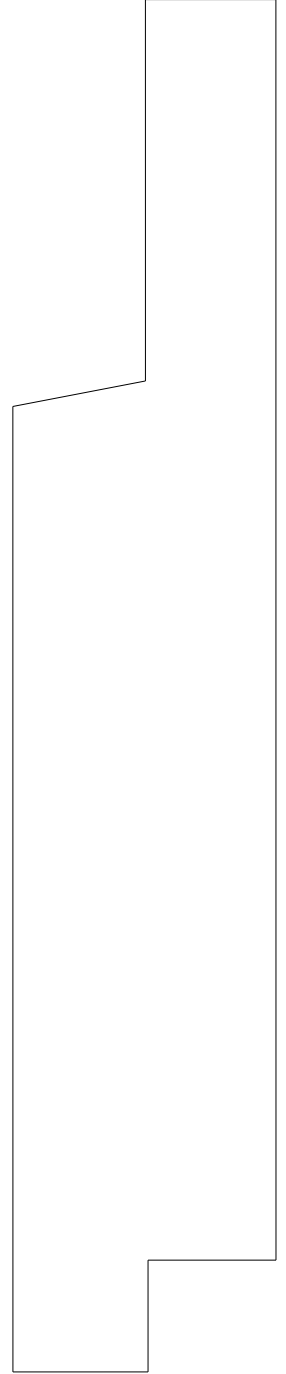

2 X 8 RMSP-151
FACE 6-5/8"

REED MILL & LUMBER CO., INC.

SIDING AND PANELING

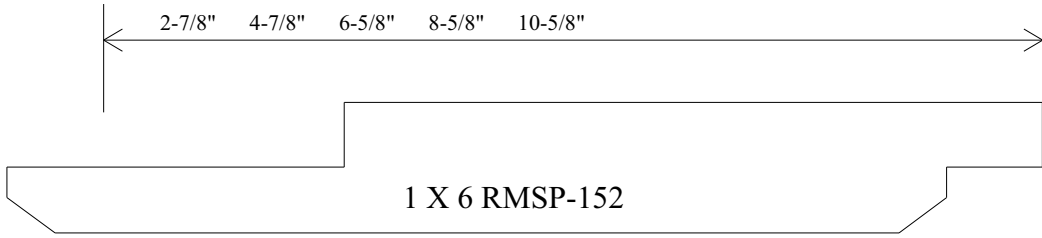

REED MILL & LUMBER CO., INC.

CEILING AND PARTITION

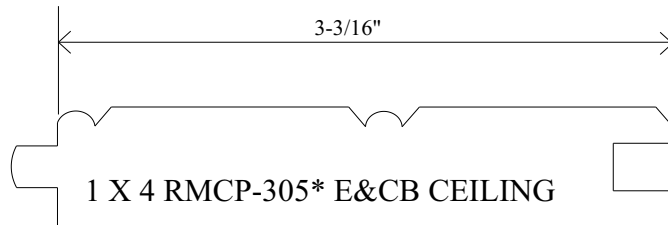
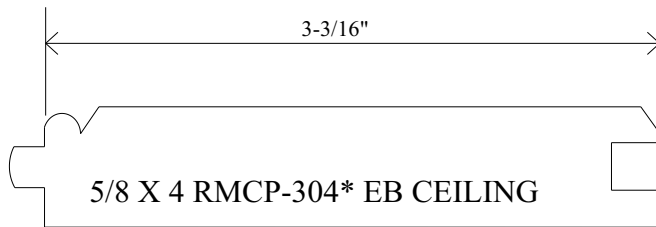
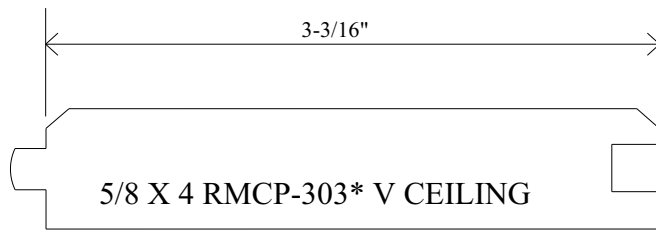
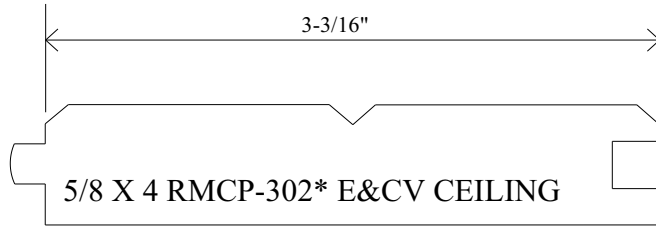
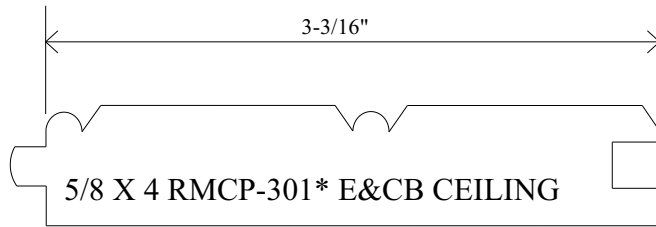

* MATCHES OR SIMILAR TO WWPA STANDARD PATTERNS

PG. CP 1

REED MILL & LUMBER CO., INC.

CEILING AND PARTITION

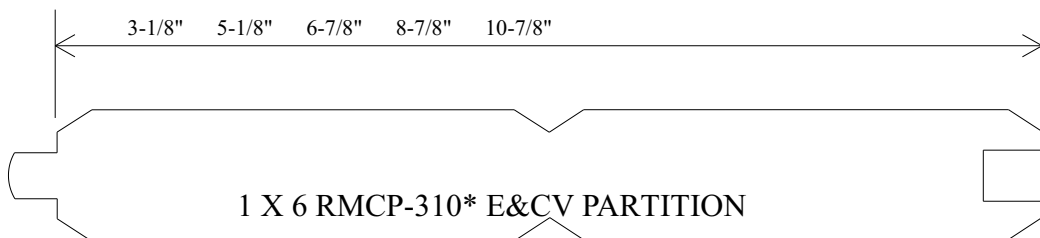
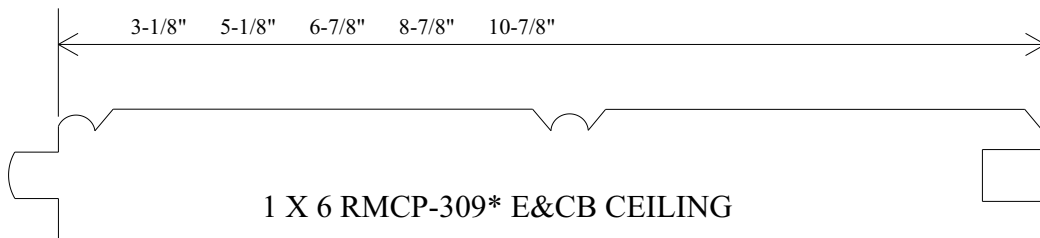
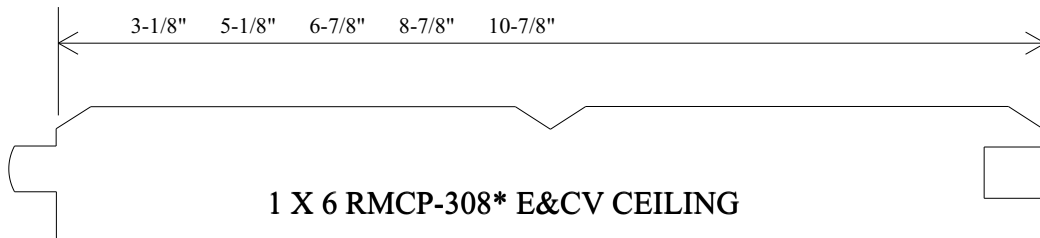
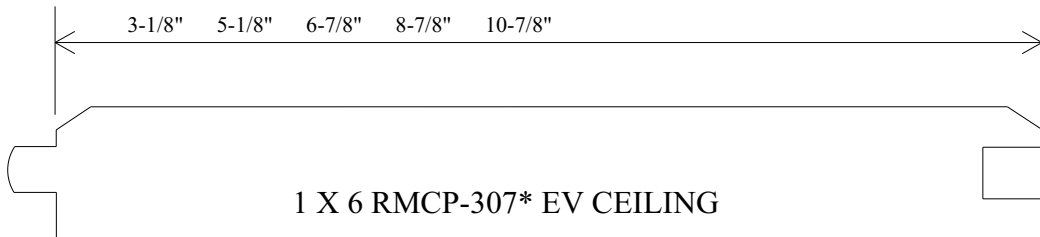
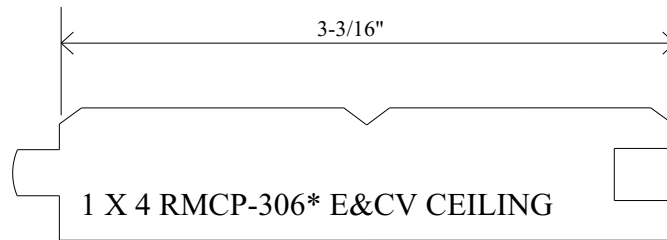

REED MILL & LUMBER CO., INC.

CEILING AND PARTITION

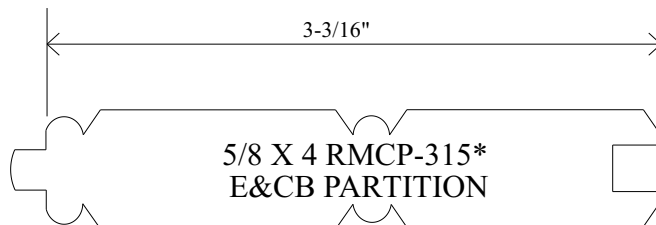
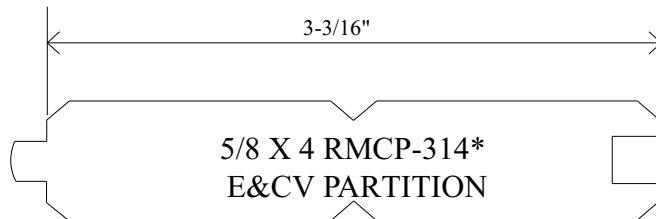
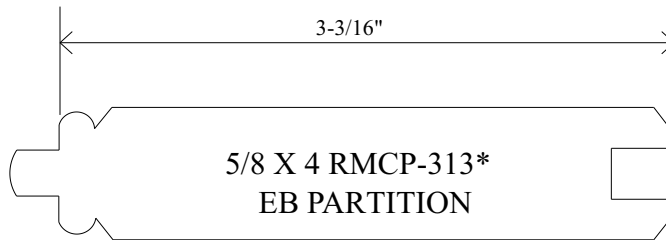
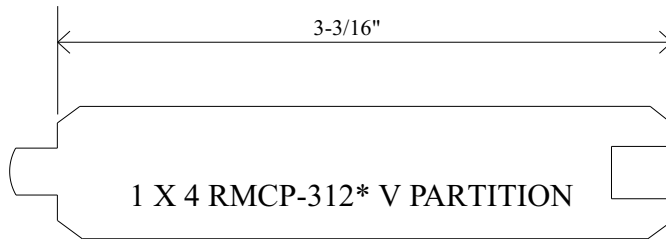
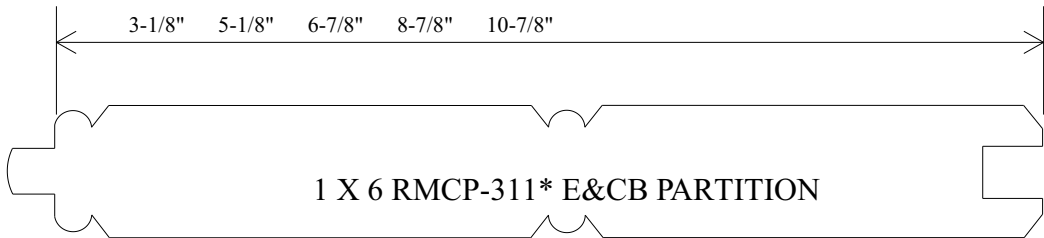

REED MILL & LUMBER CO., INC.

CEILING AND PARTITION

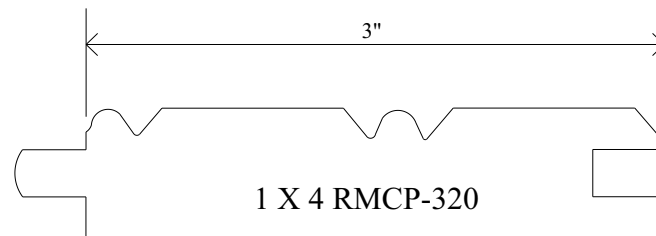
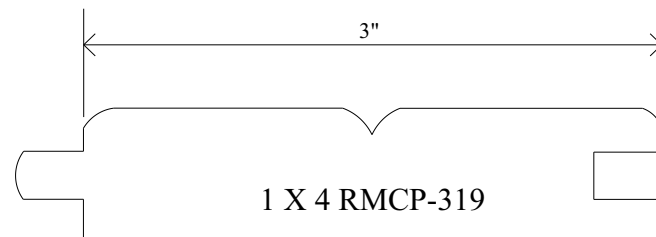
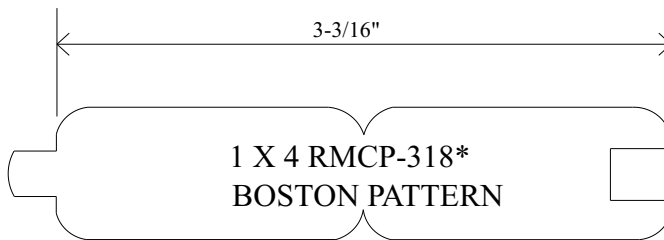
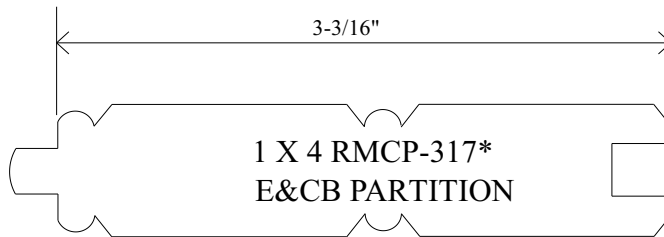
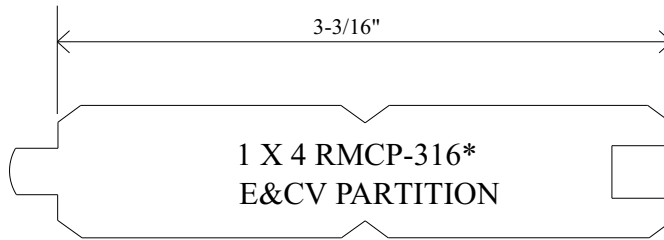

REED MILL & LUMBER CO., INC.

CEILING AND PARTITION

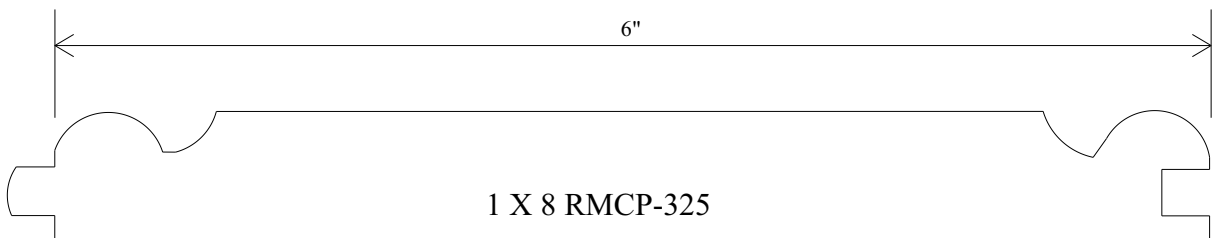
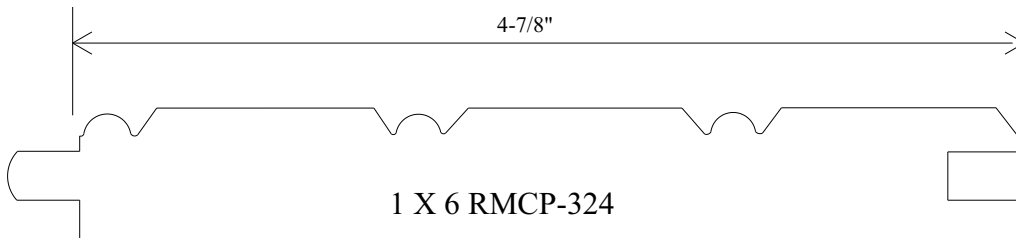
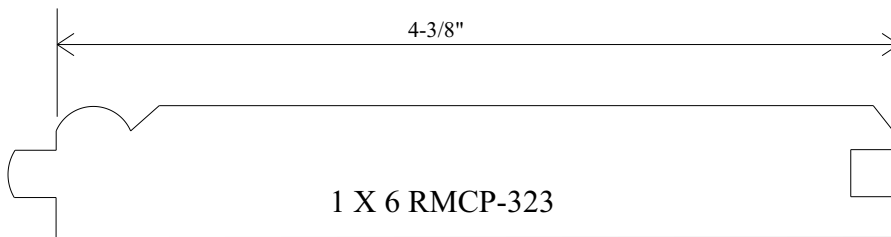
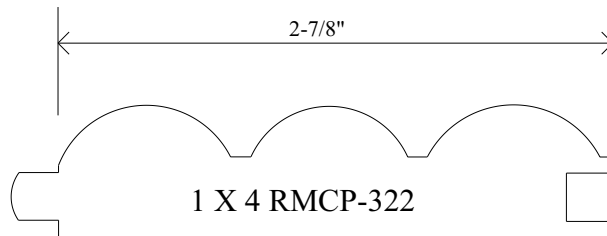
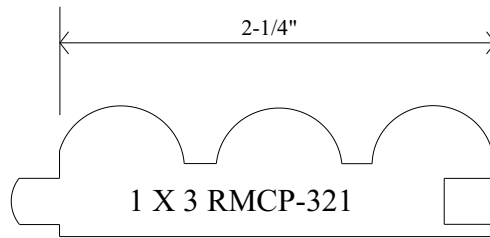

REED MILL & LUMBER CO., INC.

CEILING AND PARTITION

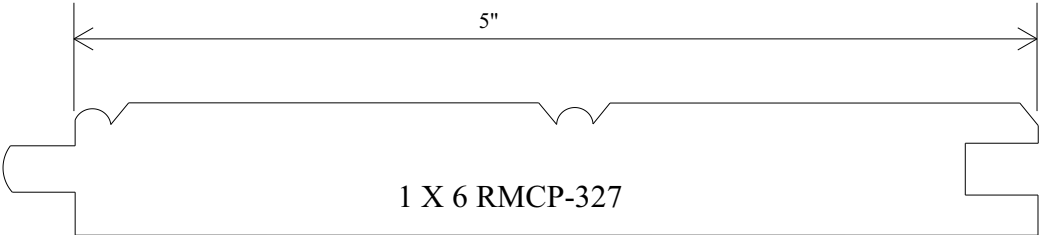
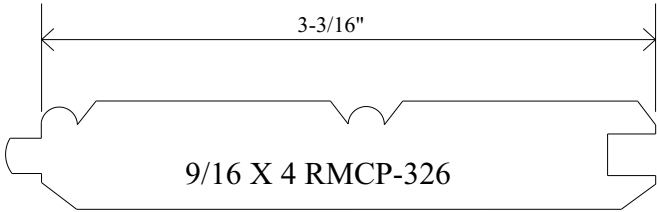

REED MILL & LUMBER CO., INC.

LOG SIDING

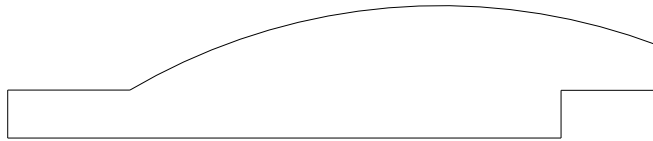

1 X 4 RMLS-401 FACE 2-7/8" REVEAL 1/8"

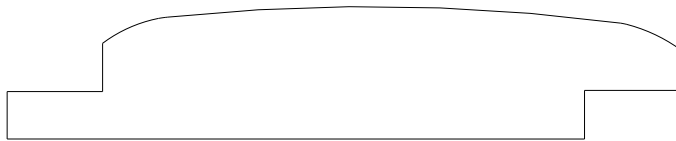

1 X 4 RMLS-402 FACE 3" NO REVEAL

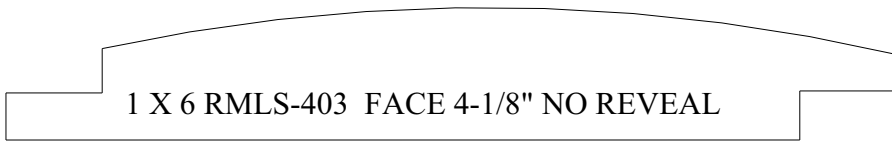

1 X 6 RMLS-403 FACE 4-1/8" NO REVEAL

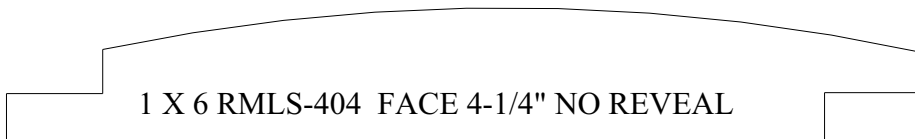

1 X 6 RMLS-404 FACE 4-1/4" NO REVEAL

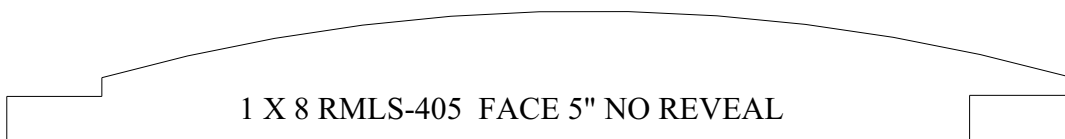

1 X 8 RMLS-405 FACE 5" NO REVEAL

REED MILL & LUMBER CO., INC.

LOG SIDING

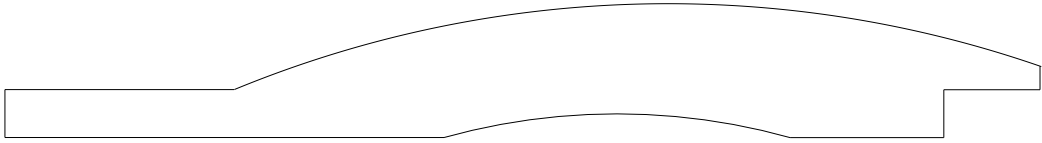

1 X 6 RMLS-406 FACE 4-7/8" REVEAL 3/4"

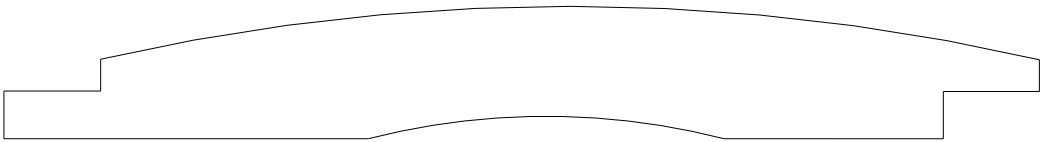

1 X 6 RMLS-407 FACE 4-7/8" NO REVEAL



1 X 8 RMLS-408 FACE 5" REVEAL 3/8"

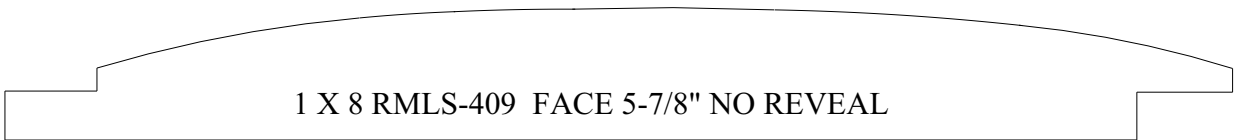

1 X 8 RMLS-409 FACE 5-7/8" NO REVEAL

REED MILL & LUMBER CO., INC.

LOG SIDING

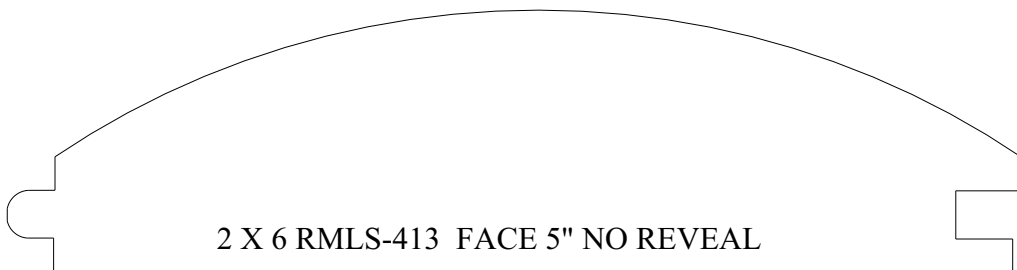
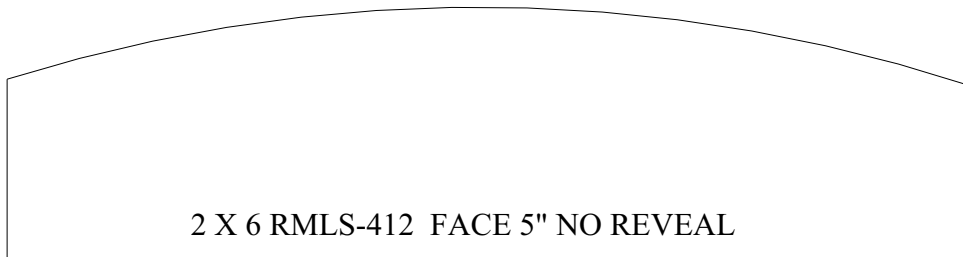
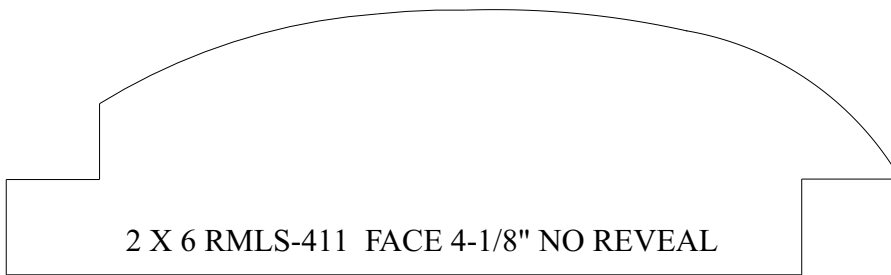
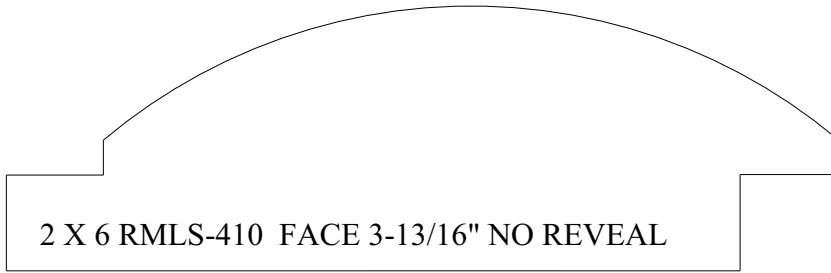

REED MILL & LUMBER CO., INC.

LOG SIDING

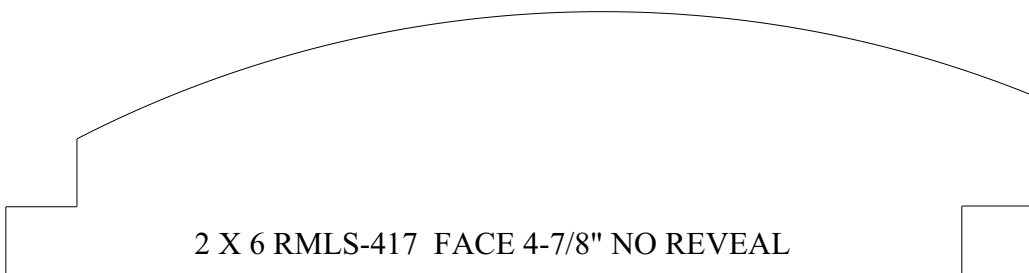
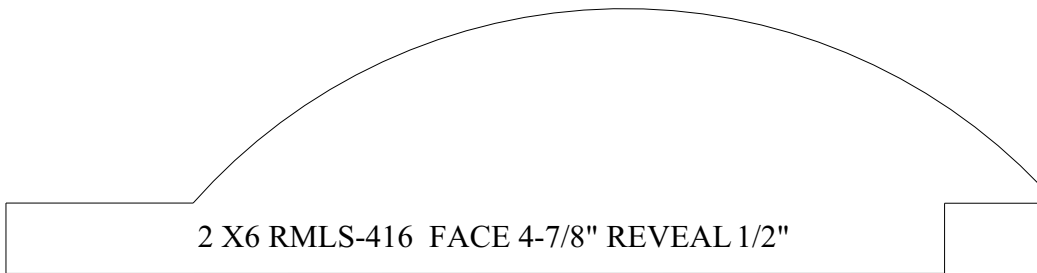
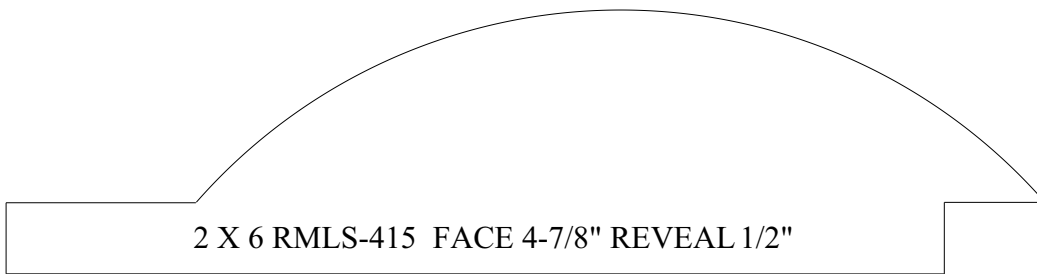
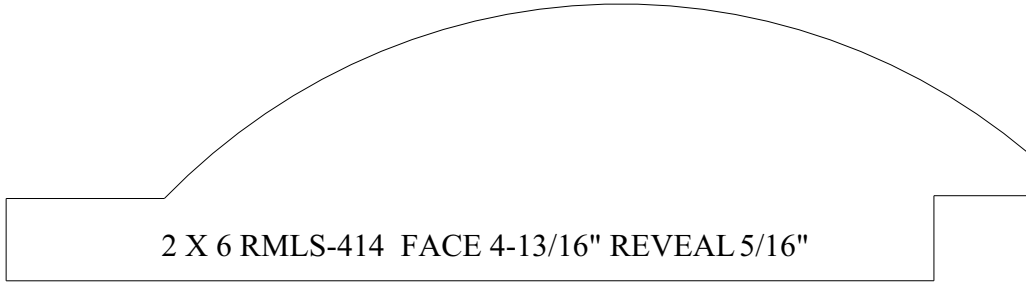

REED MILL & LUMBER CO., INC.

LOG SIDING

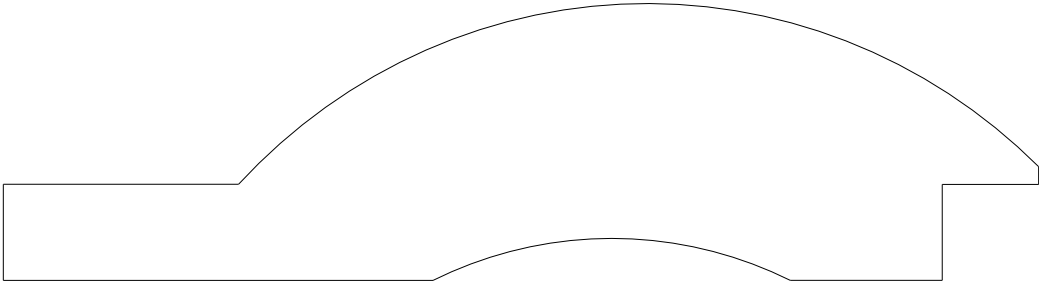

2 X 6 RMLS-418 FACE 4-7/8" REVEAL 3/4"

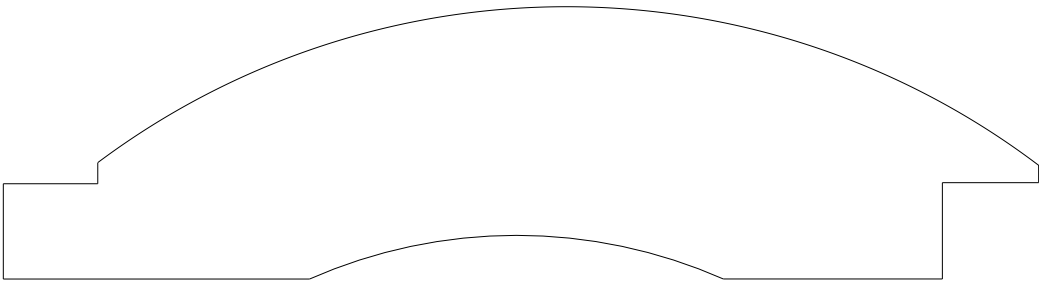

2 X 6 RMLS-419 FACE 4-7/8" NO REVEAL

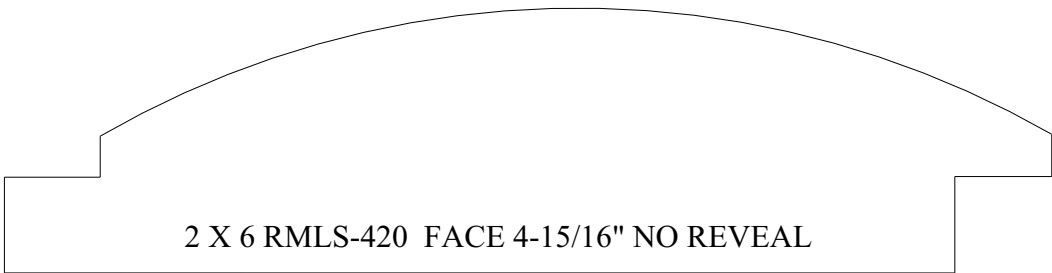

2 X 6 RMLS-420 FACE 4-15/16" NO REVEAL

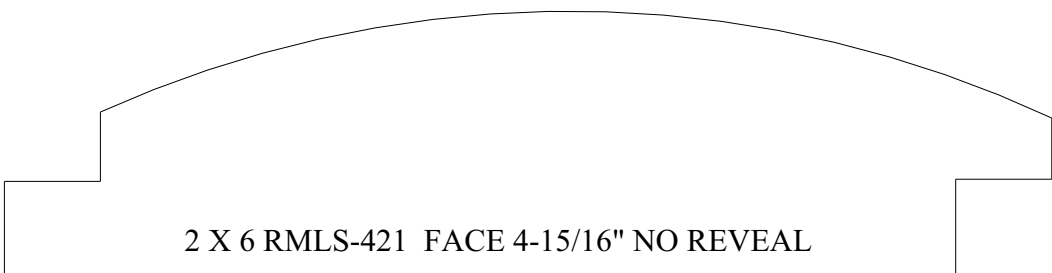

2 X 6 RMLS-421 FACE 4-15/16" NO REVEAL

REED MILL & LUMBER CO., INC.

LOG SIDING

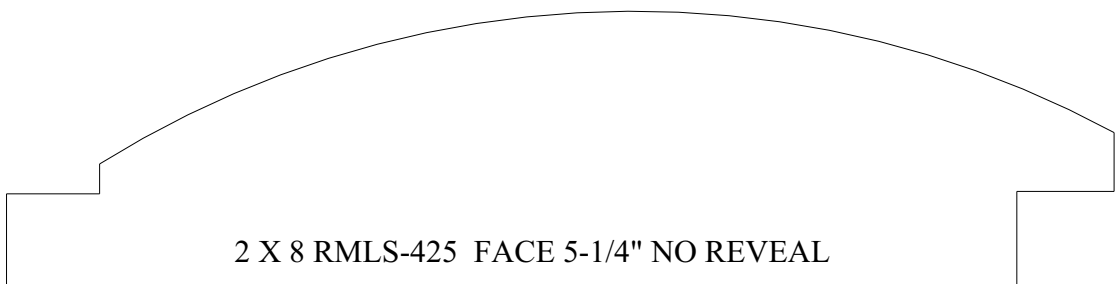
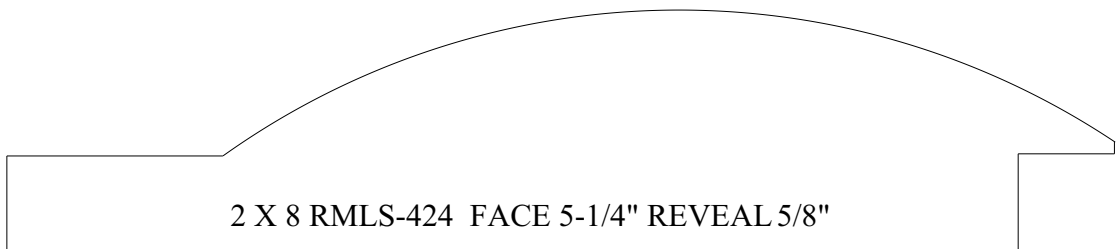
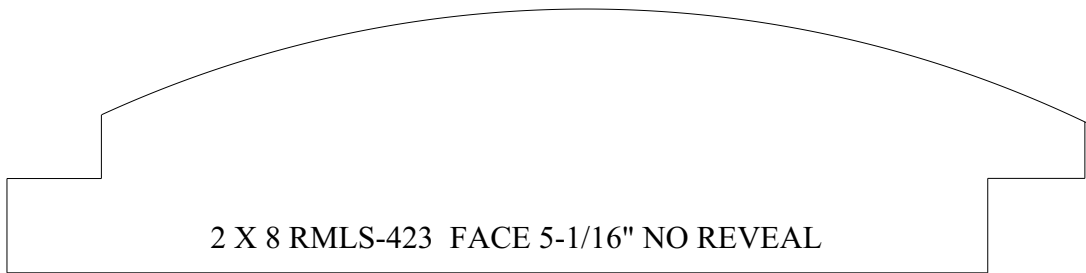
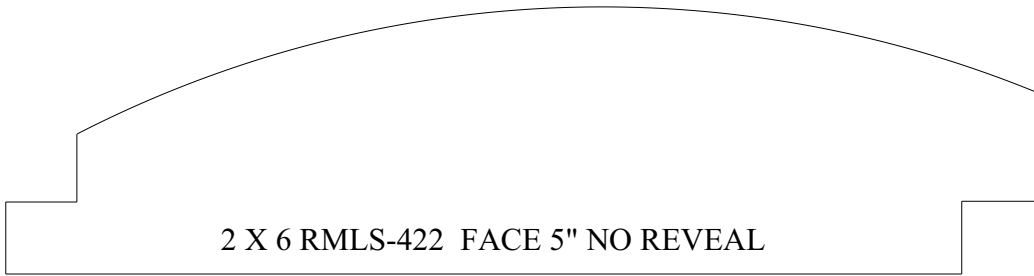

REED MILL & LUMBER CO., INC.

LOG SIDING

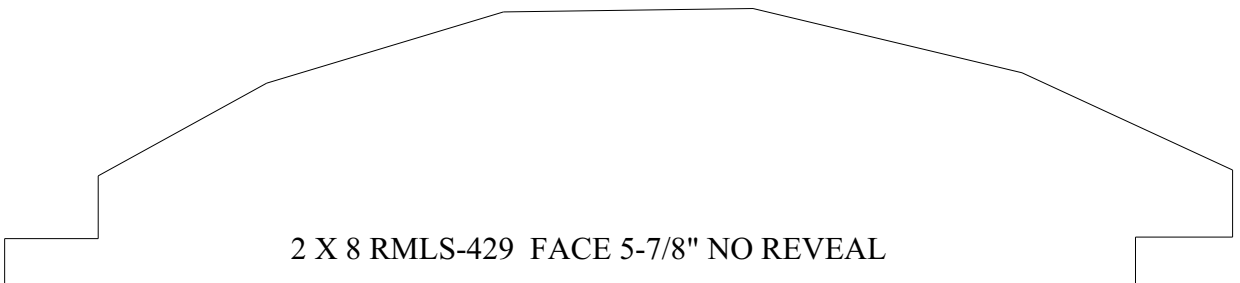
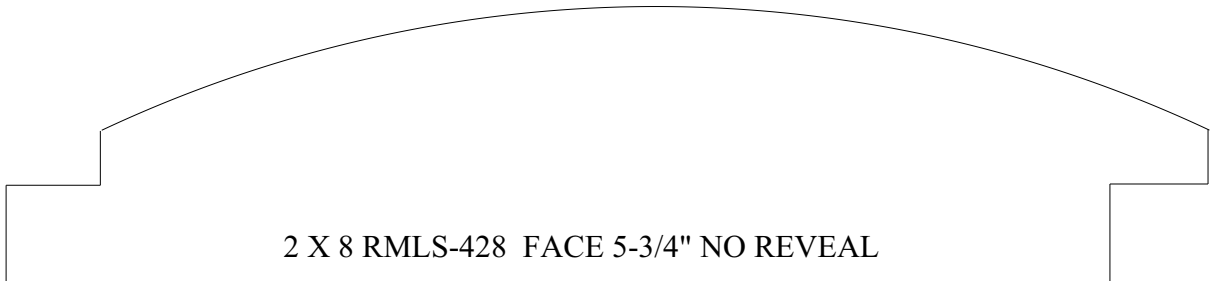
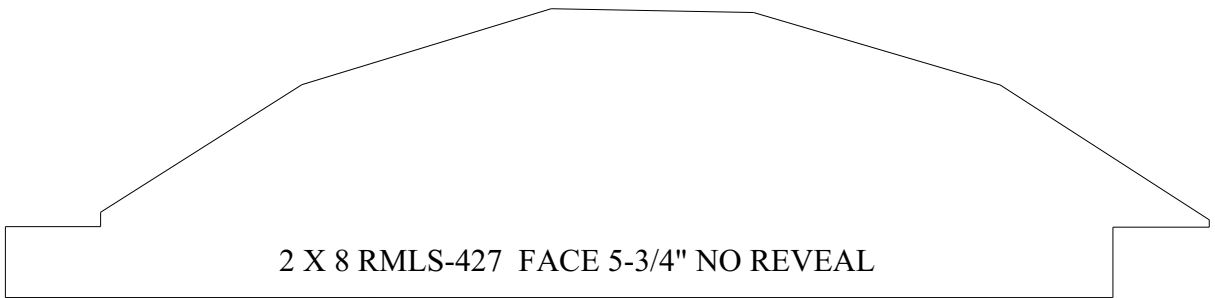
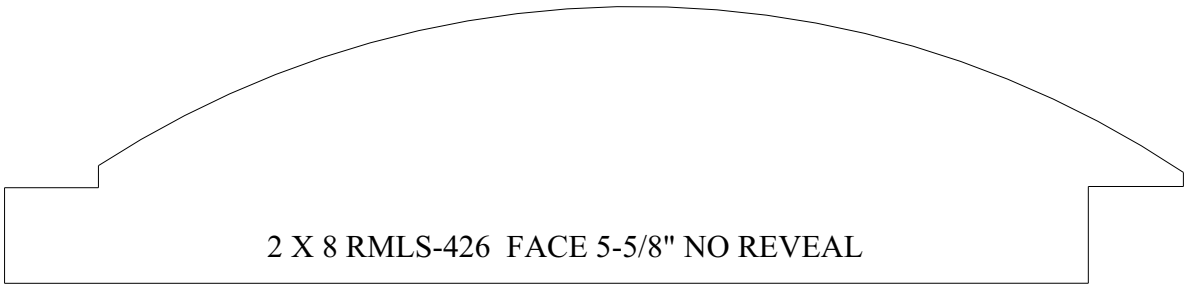

REED MILL & LUMBER CO., INC.

LOG SIDING

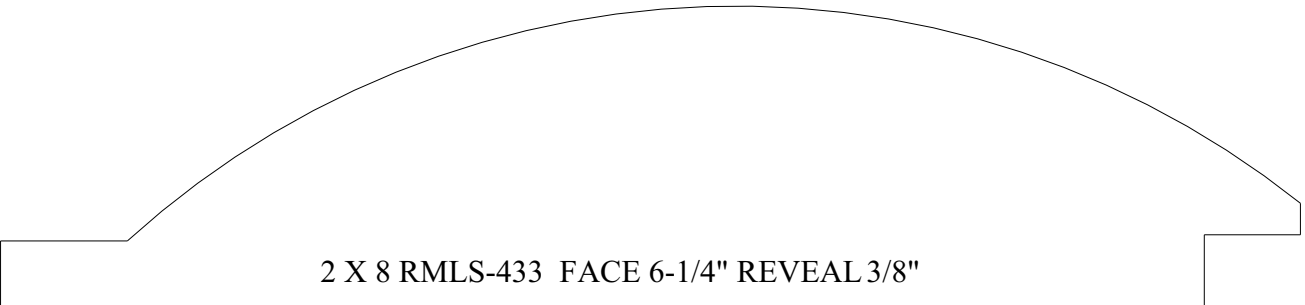
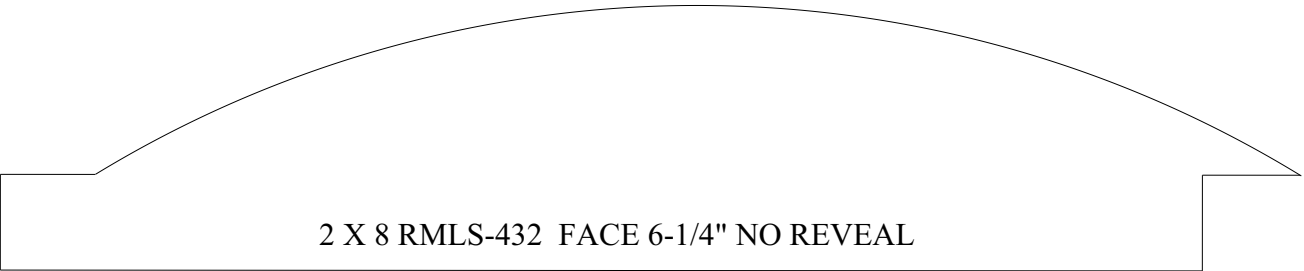
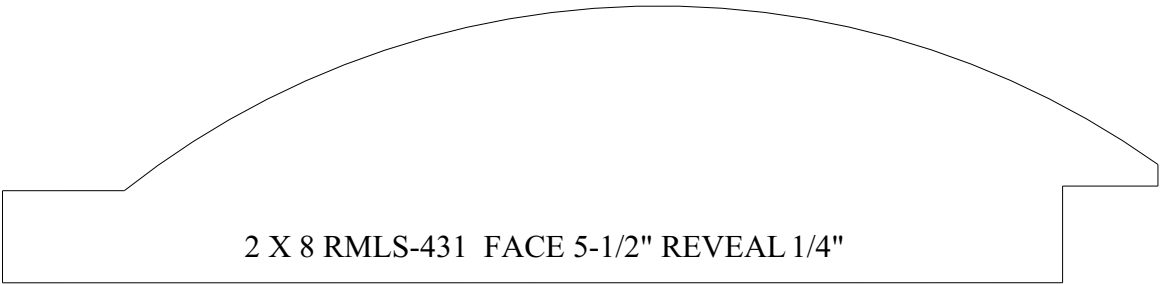
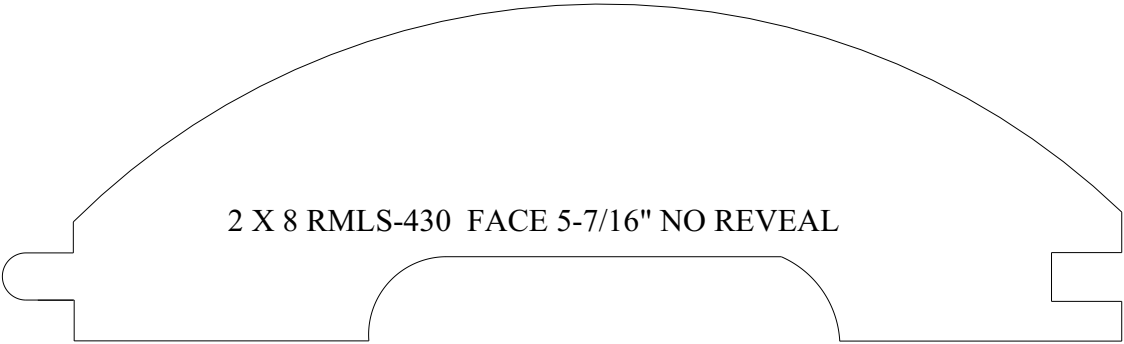

REED MILL & LUMBER CO., INC.

LOG SIDING

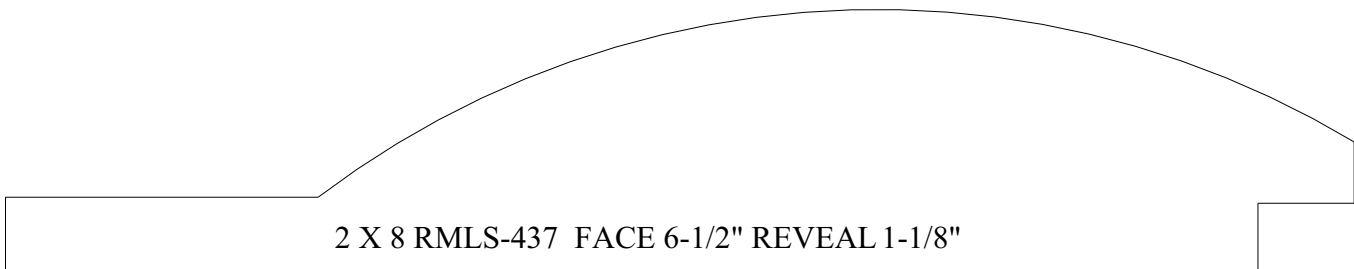
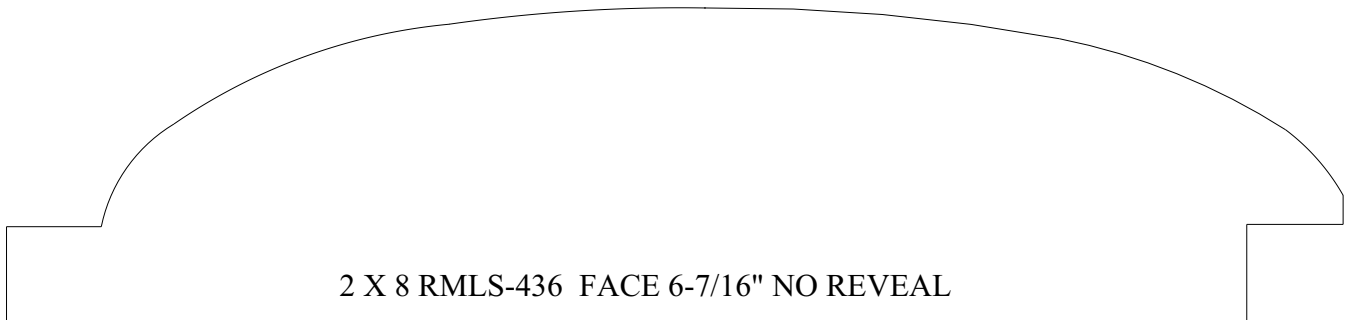
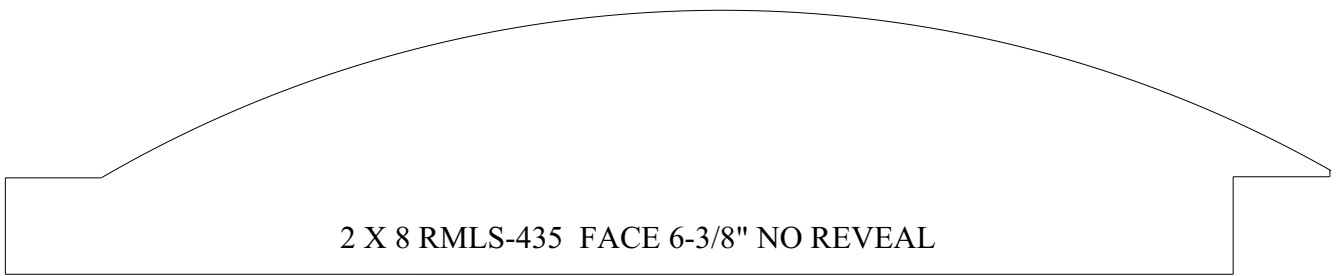
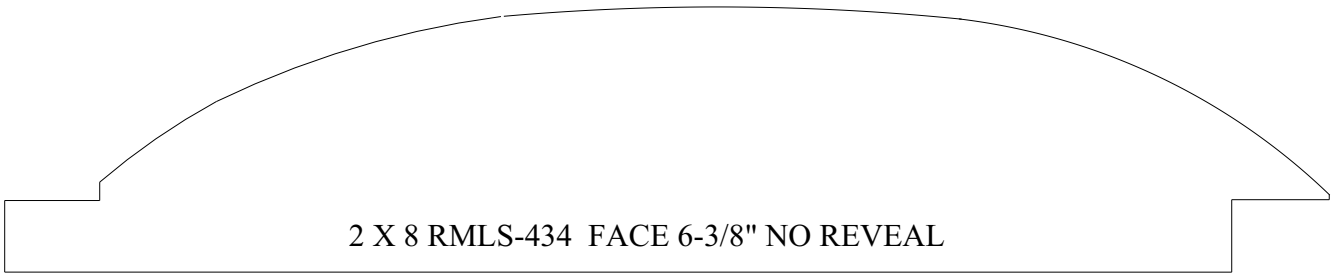

REED MILL & LUMBER CO., INC.

LOG SIDING

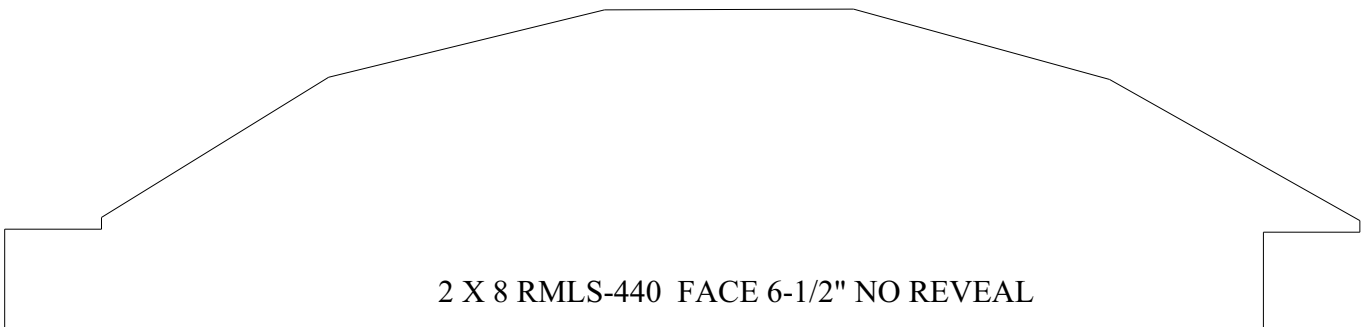
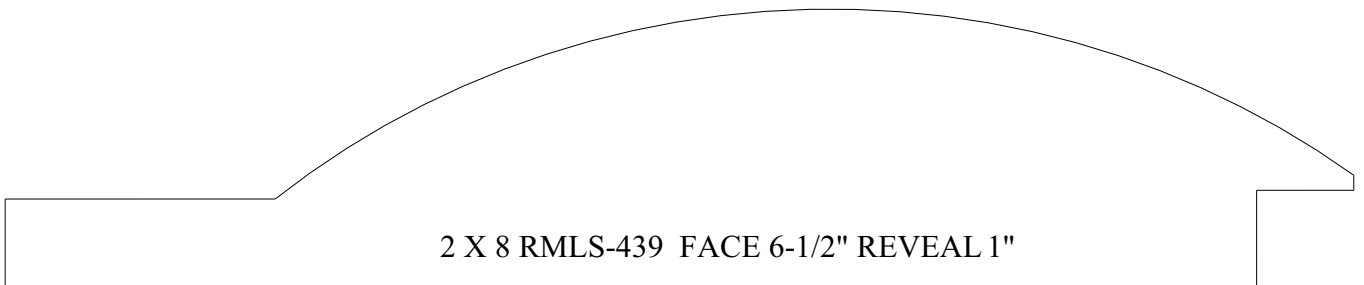
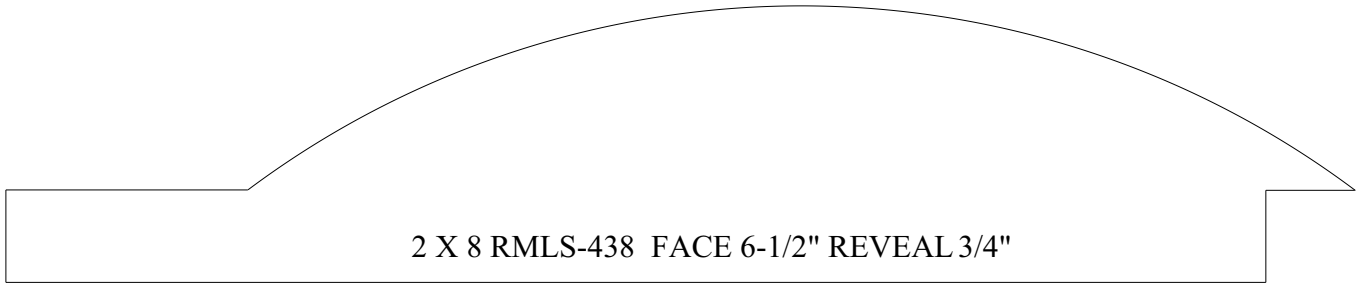

REED MILL & LUMBER CO., INC.

LOG SIDING

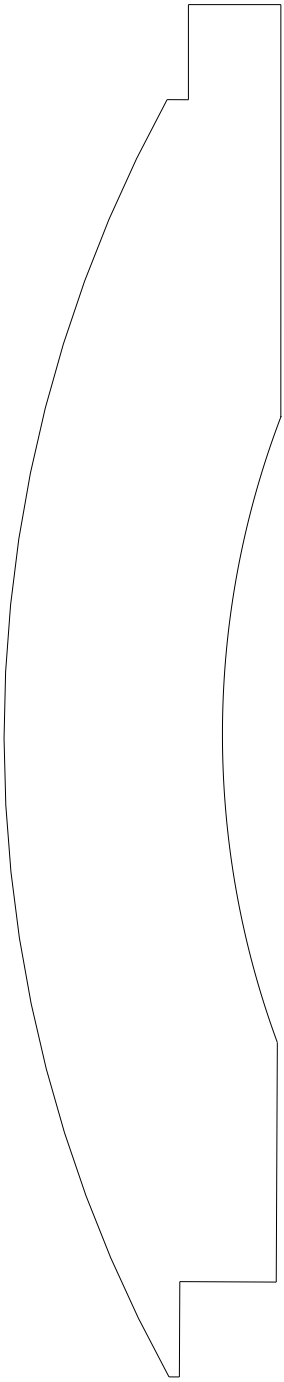

2 X 8 RMLS-441
FACE 6-5/8" NO REVEAL

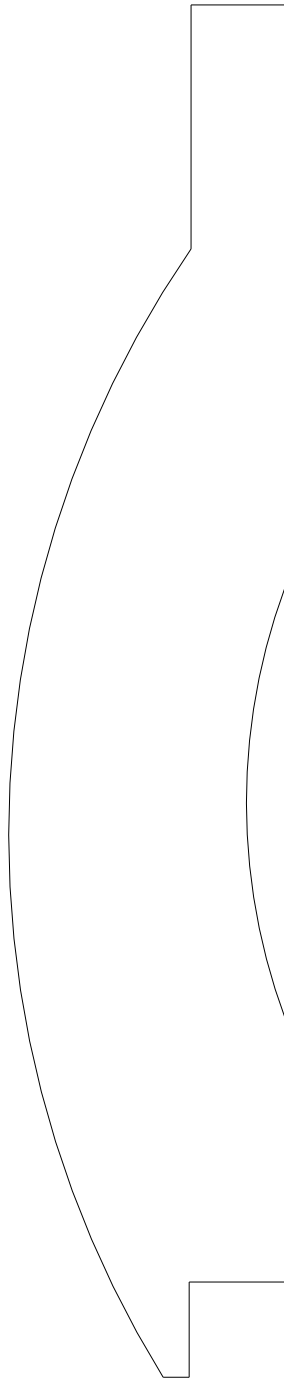

2 X 8 RMLS-442
FACE 6-5/8" REVEAL 3/4"

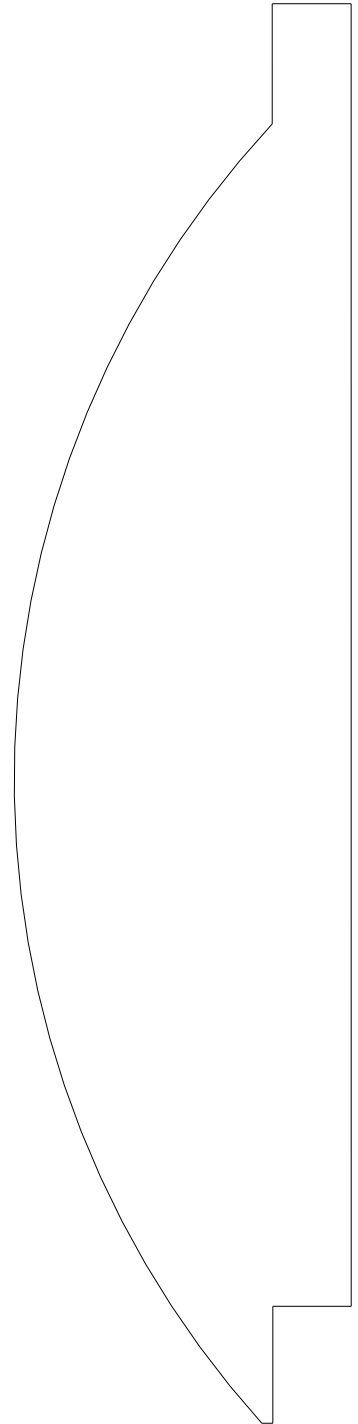

2 X 10 RMLS-443
FACE 6-3/4" REVEAL 1/8"

REED MILL & LUMBER CO., INC.

LOG SIDING

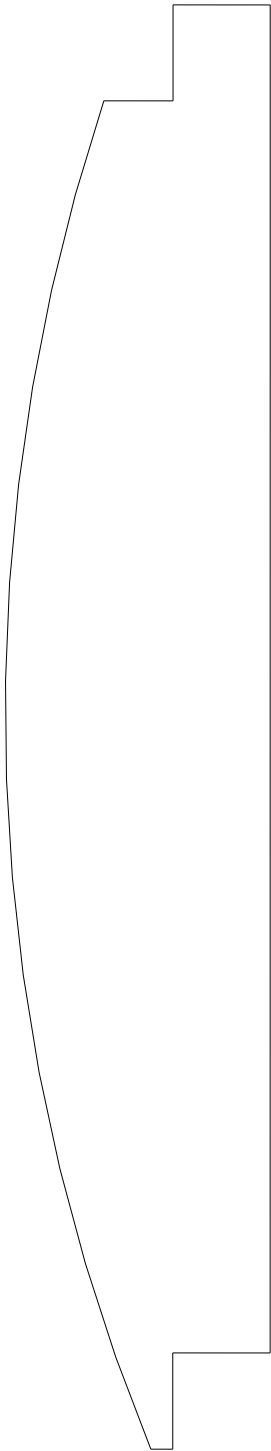

2 X 10 RMLS-444
FACE 7"
NO REVEAL

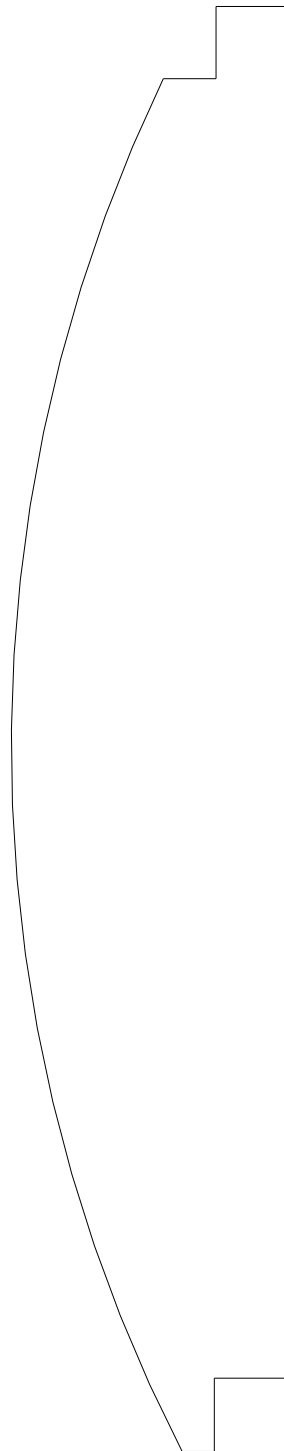

2 X 10 RMLS-445
FACE 7"
NO REVEAL

REED MILL & LUMBER CO., INC.

LOG SIDING

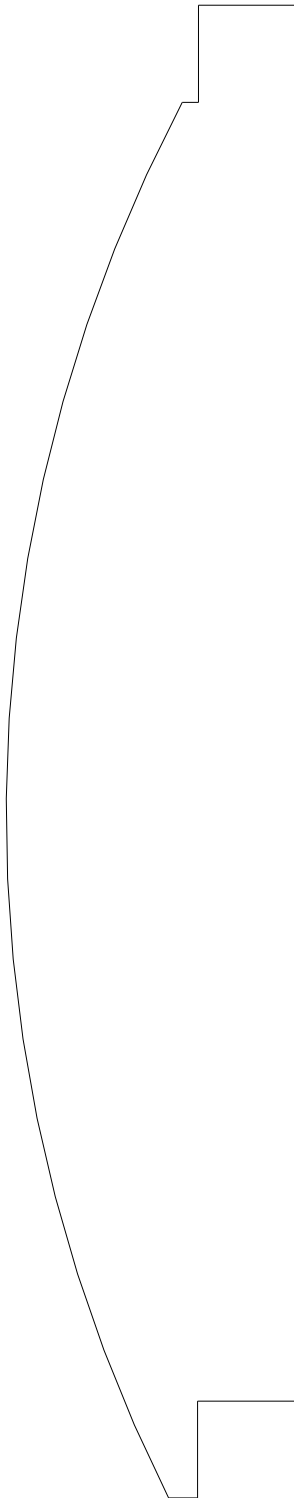

2 X 10 RMLS-446
FACE 7-1/4"

NO REVEAL

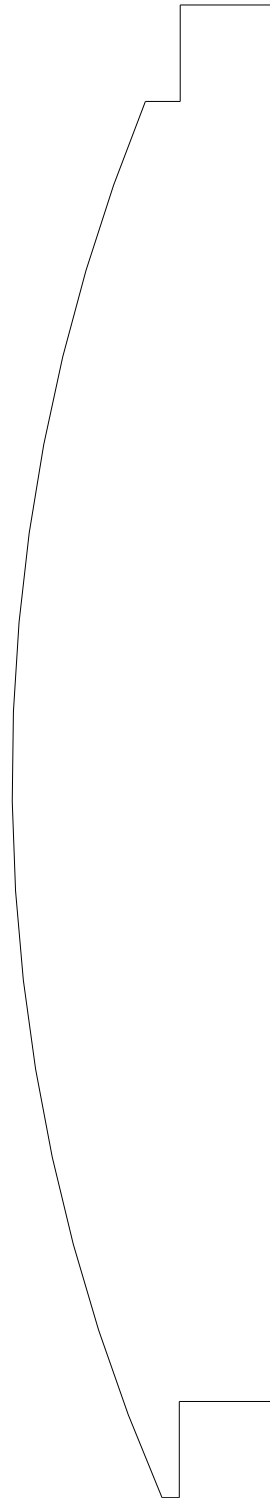

2 X 10 RMLS-447
FACE 7-1/4"

NO REVEAL

REED MILL & LUMBER CO., INC.

LOG SIDING

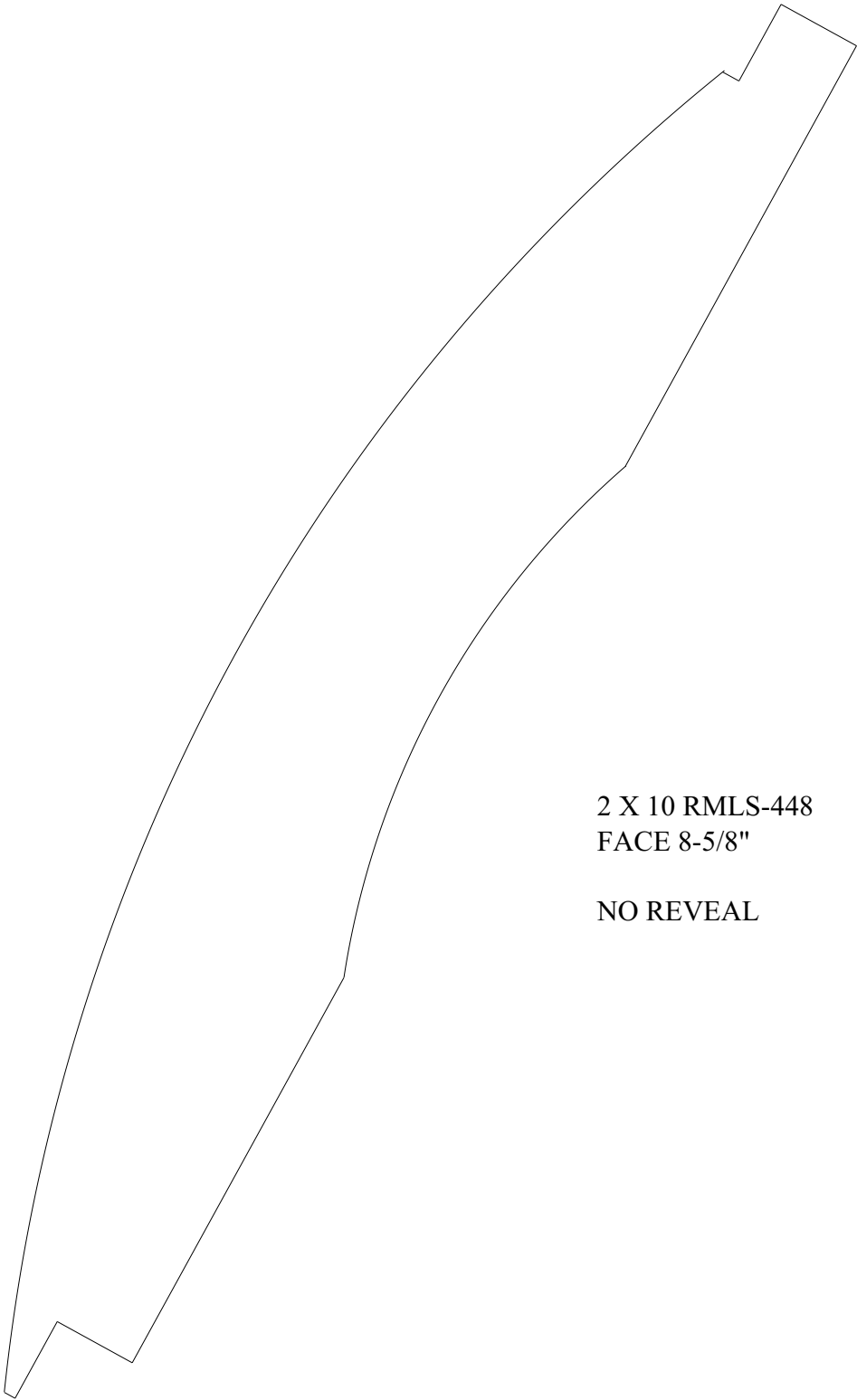

2 X 10 RMLS-448
FACE 8-5/8"

NO REVEAL

REED MILL & LUMBER CO., INC.

LOG SIDING

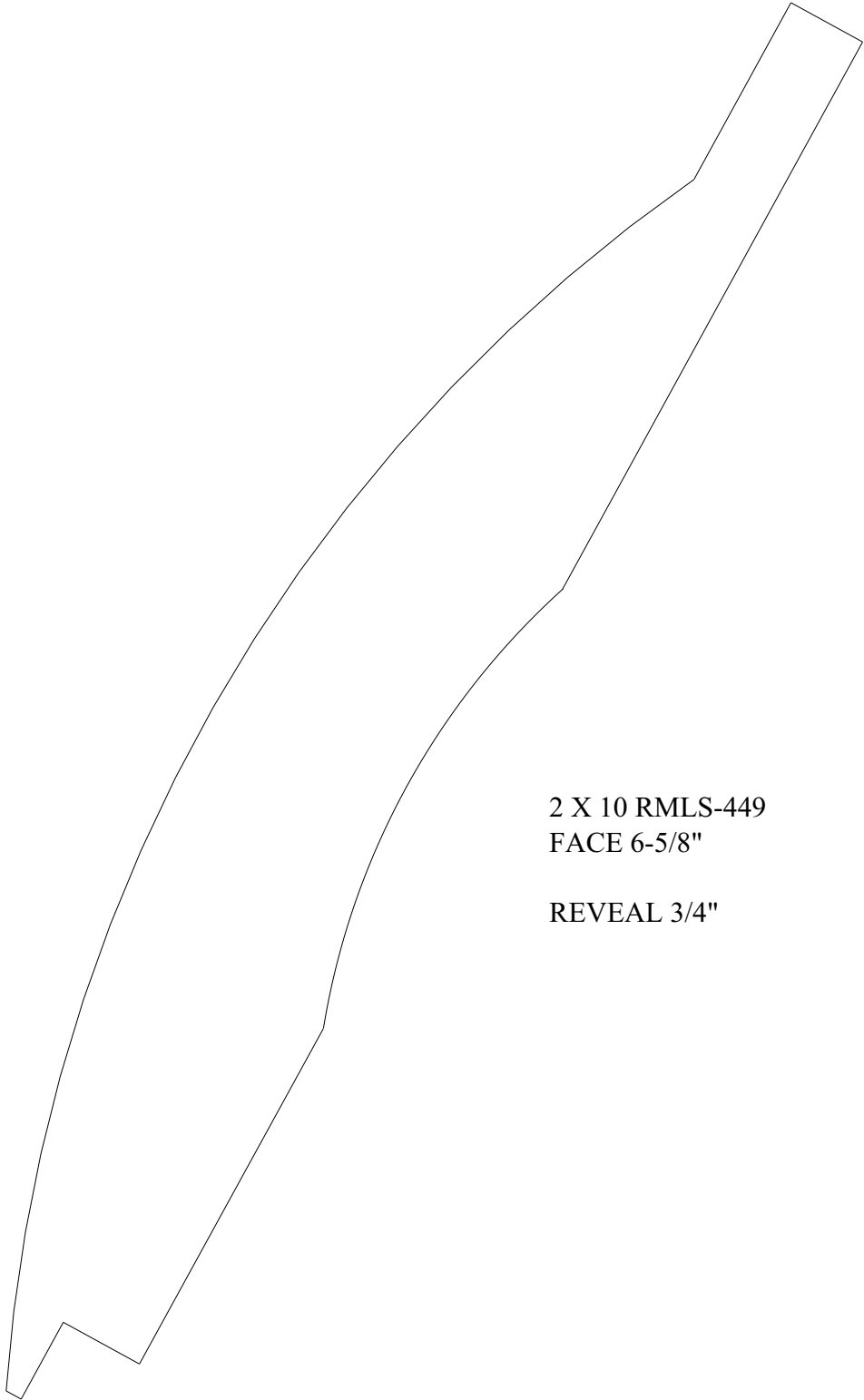

2 X 10 RMLS-449
FACE 6-5/8"

REVEAL 3/4"

REED MILL & LUMBER CO., INC.

LOG SIDING

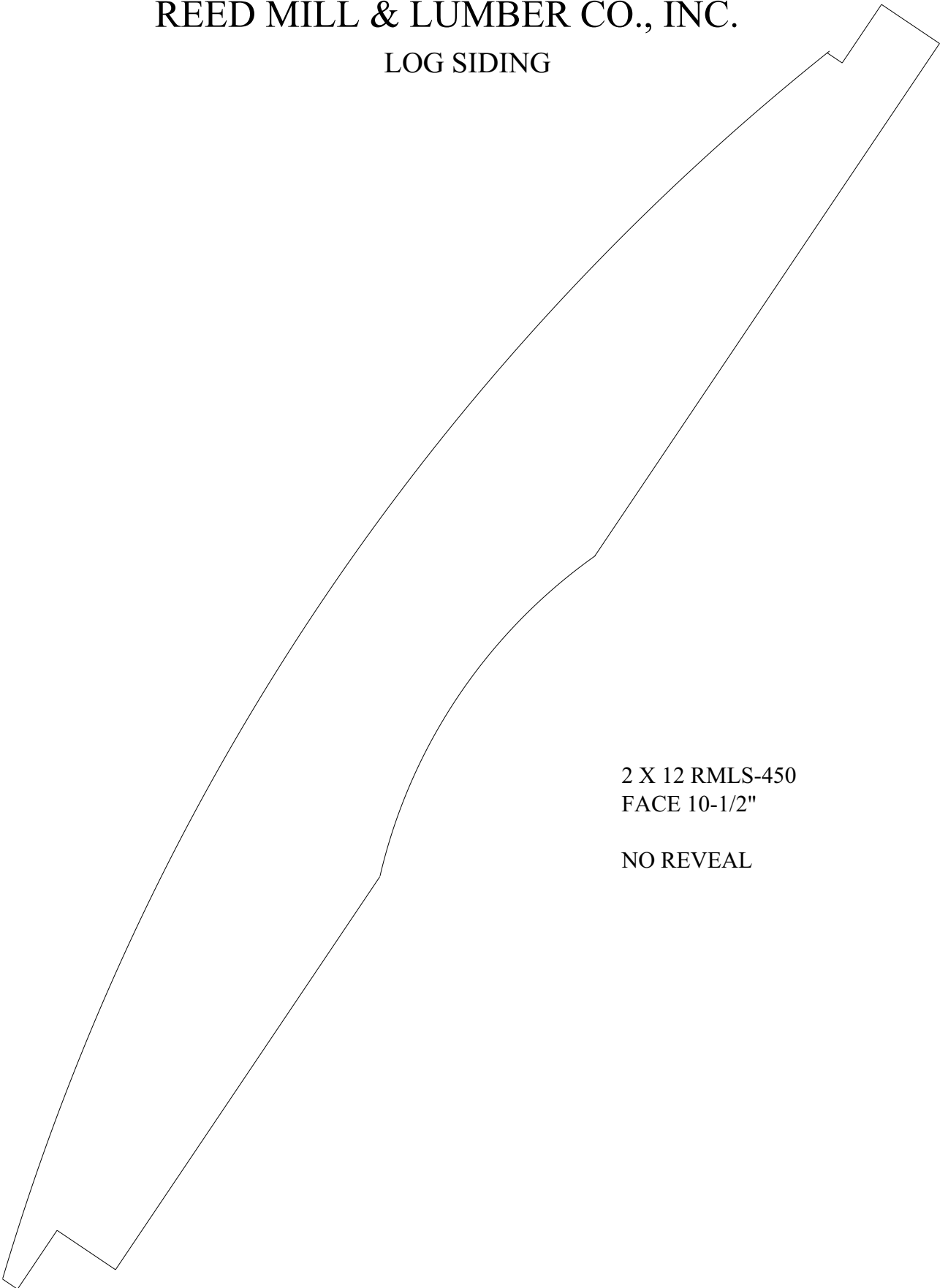

2 X 12 RMLS-450
FACE 10-1/2"

NO REVEAL

REED MILL & LUMBER CO., INC.

LOG SIDING

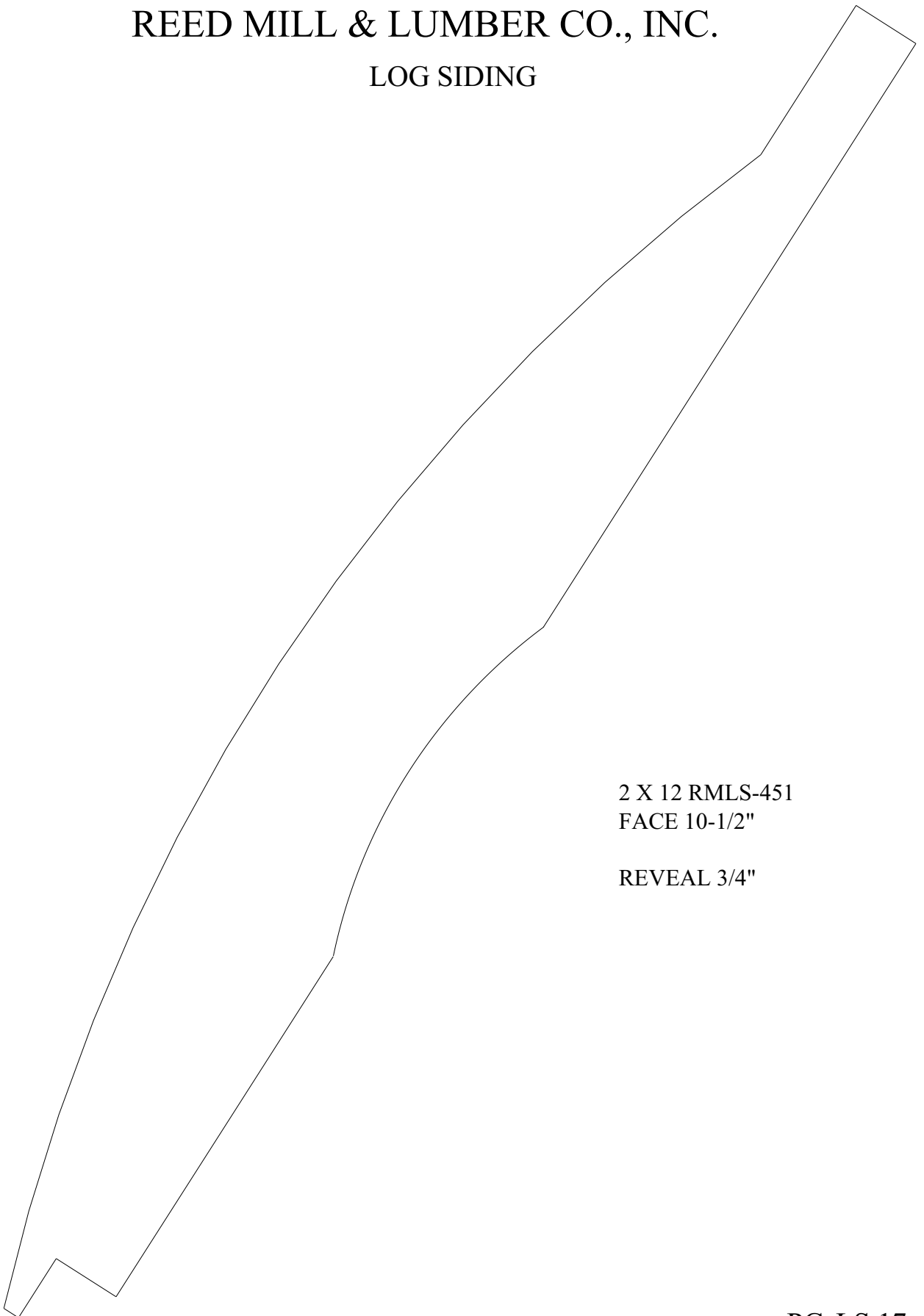

2 X 12 RMLS-451
FACE 10-1/2"

REVEAL 3/4"

REED MILL & LUMBER CO., INC.

LOG SIDING

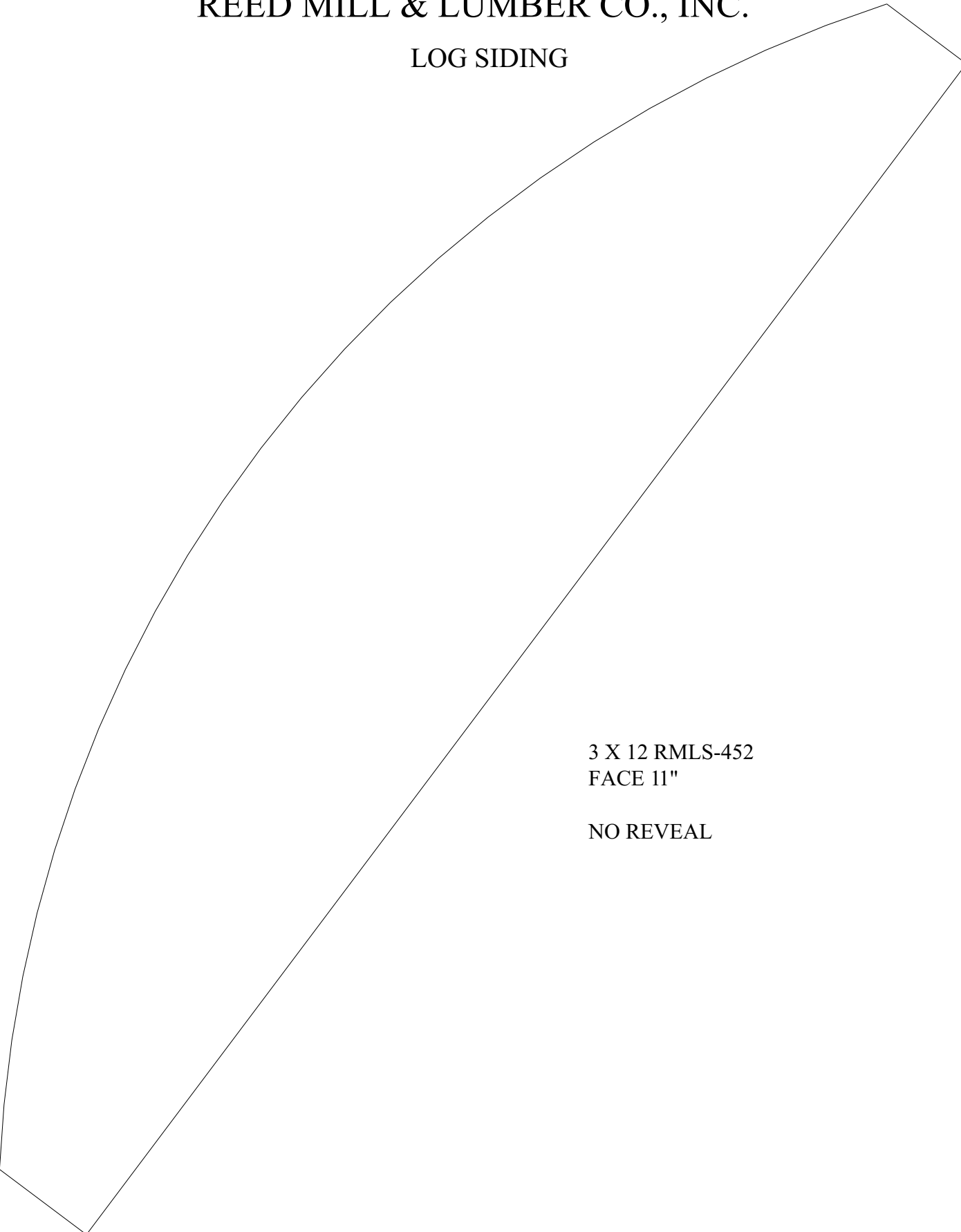

3 X 12 RMLS-452
FACE 11"

NO REVEAL

REED MILL & LUMBER CO., INC.

FLOORING

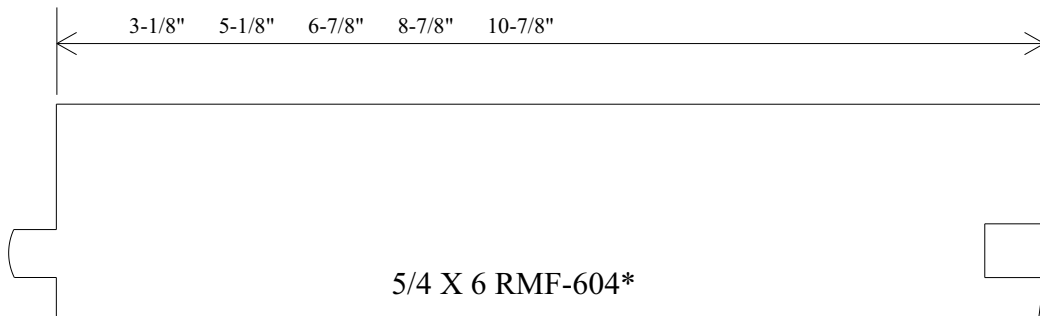
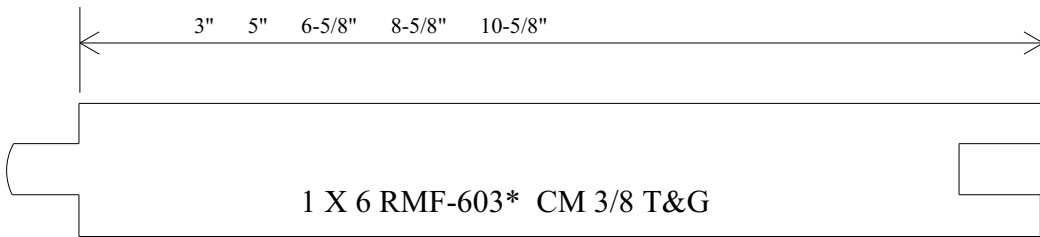
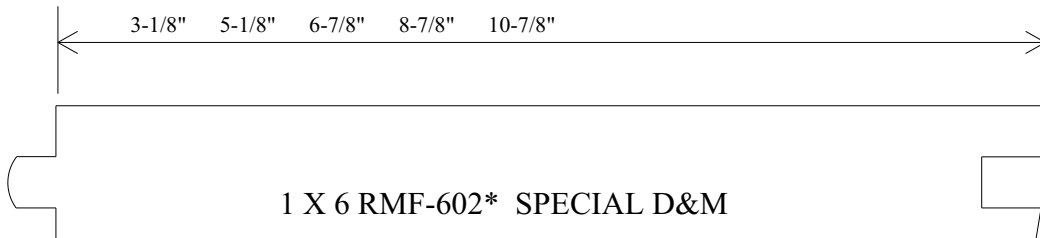
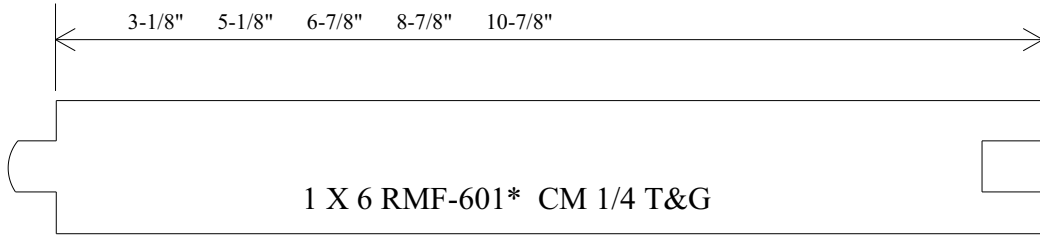

* MATCHES OR SIMILAR TO WWPA STANDARD PATTERNS

PG. F 1

REED MILL & LUMBER CO., INC.

FLOORING

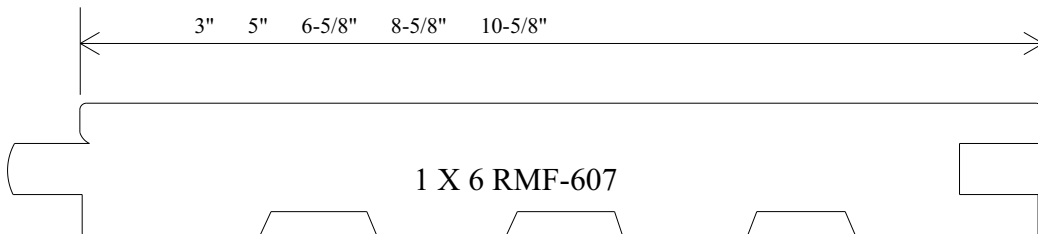
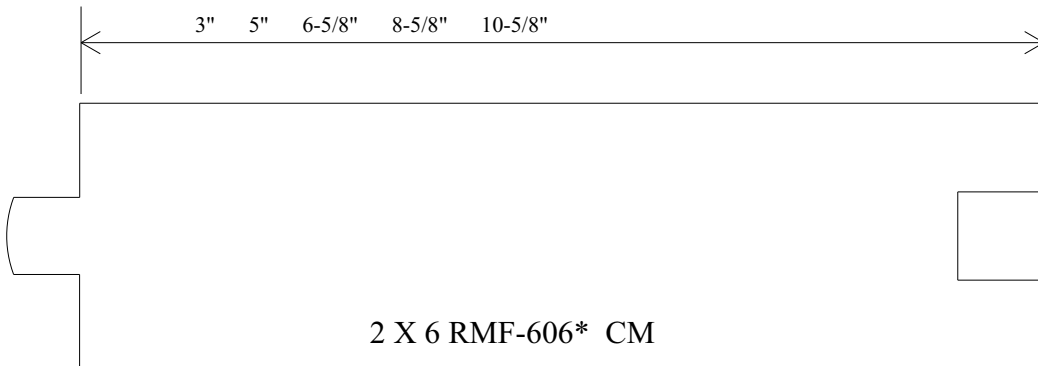
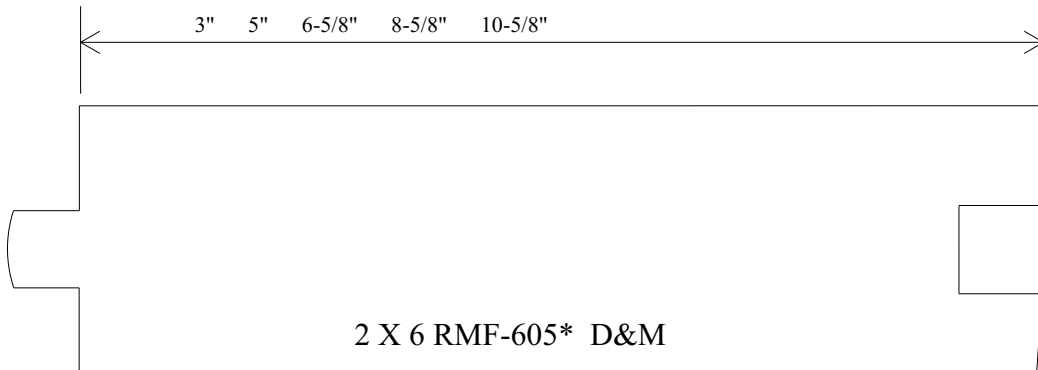

* MATCHES OR SIMILAR TO WWPA STANDARD PATTERNS

REED MILL & LUMBER CO., INC.

SHIPLAP

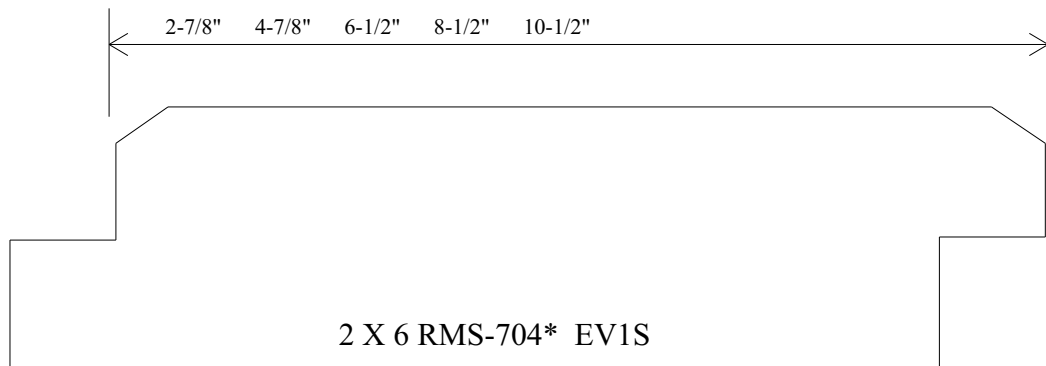
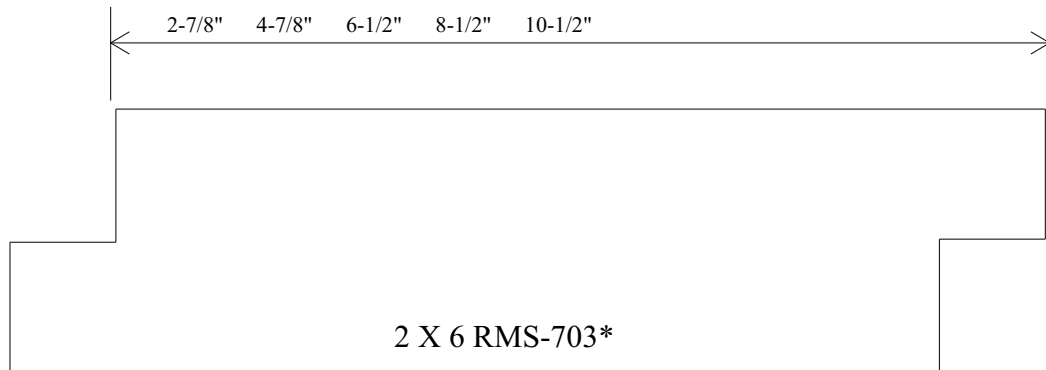
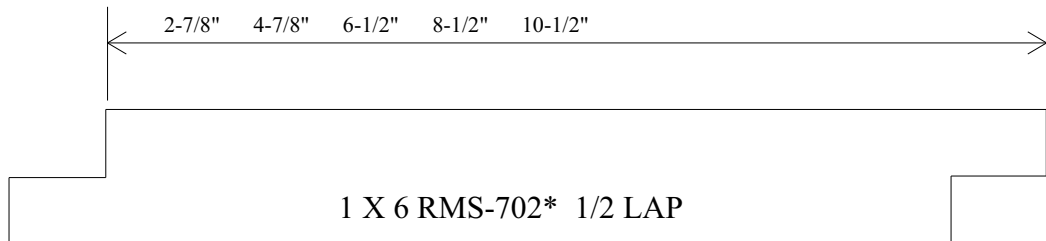
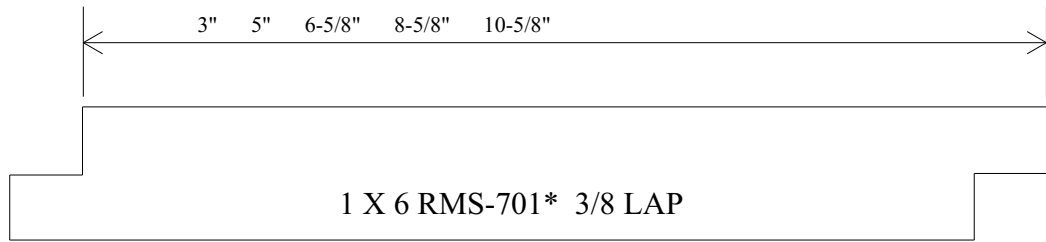

* MATCHES OR SIMILAR TO WWPA STANDARD PATTERNS

PG. S 1

REED MILL & LUMBER CO., INC.

SHIPLAP

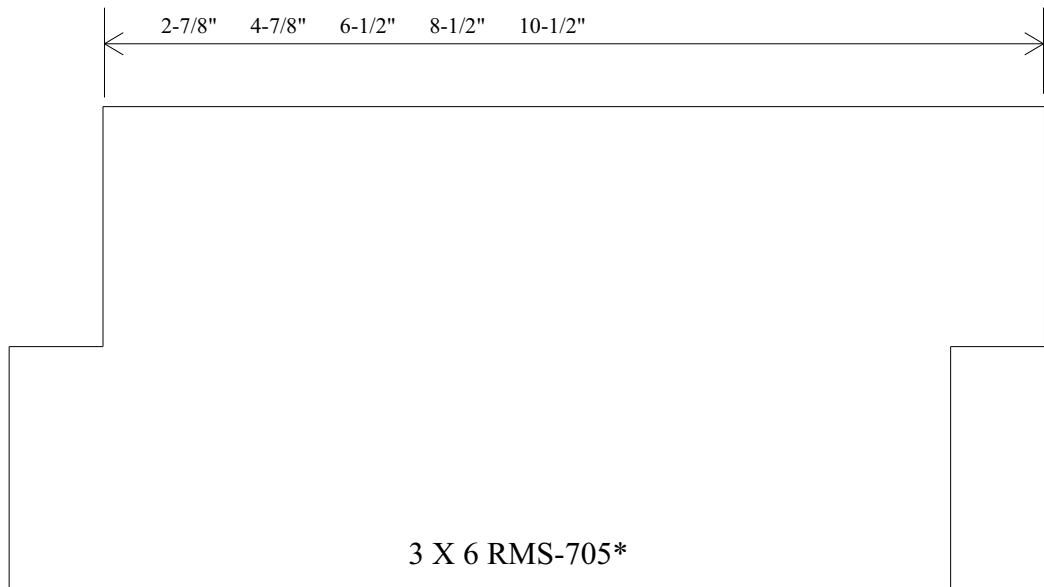

REED MILL & LUMBER CO., INC.

DECKING

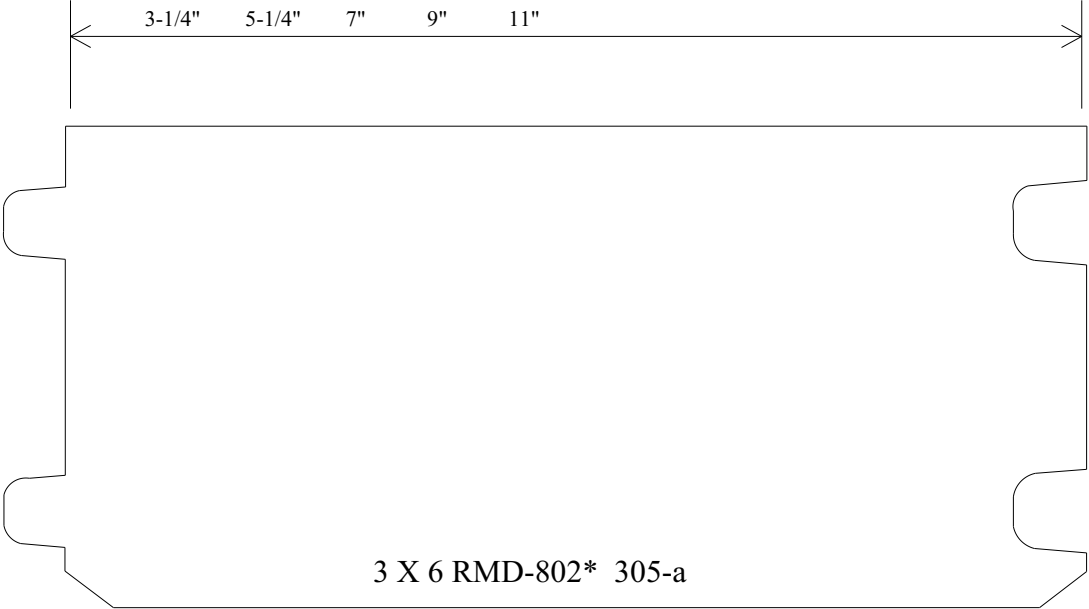
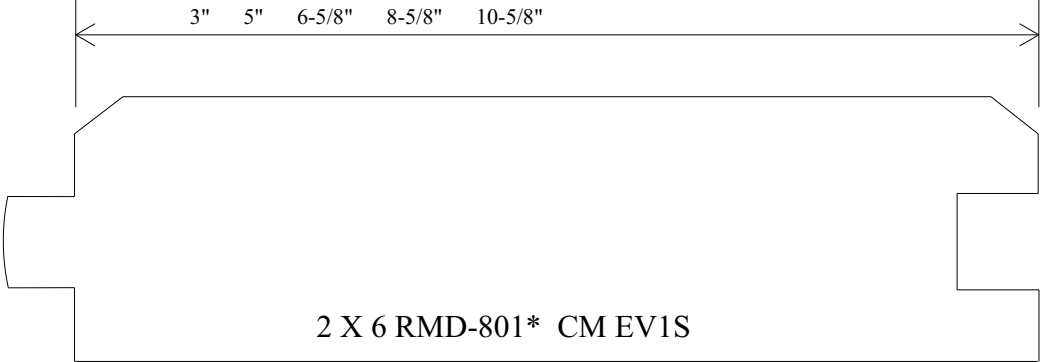

* MATCHES OR SIMILAR TO WWPA STANDARD PATTERNS

REED MILL & LUMBER CO., INC.

DECKING

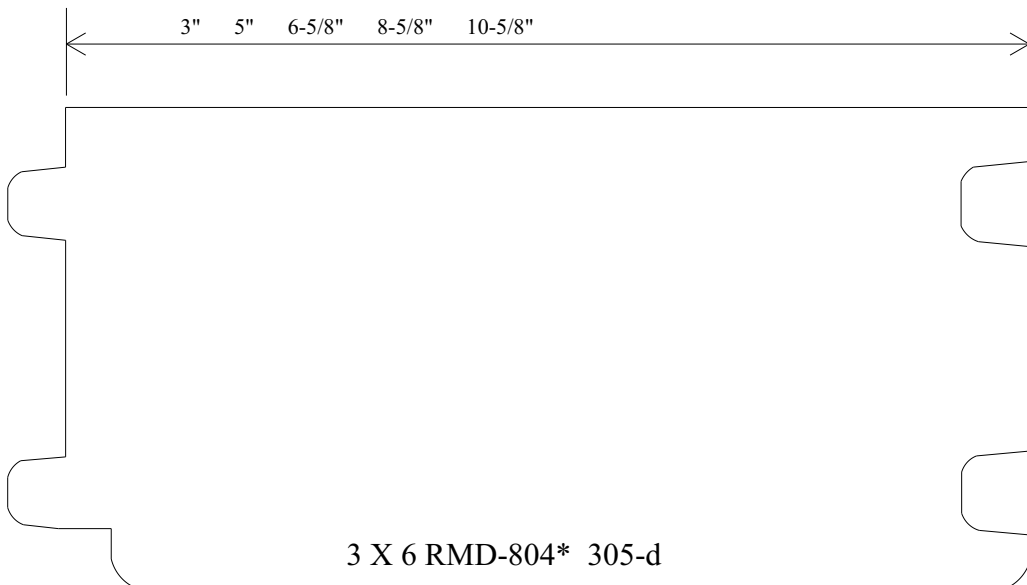
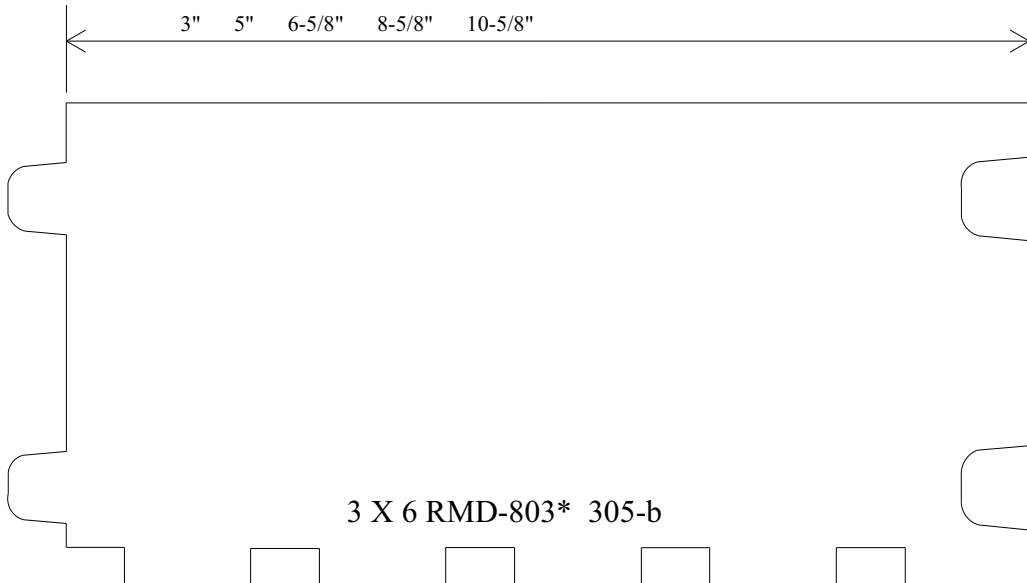

* MATCHES OR SIMILAR TO WHPA STANDARD PATTERNS

PG. D 2

REED MILL & LUMBER CO., INC.

DECKING

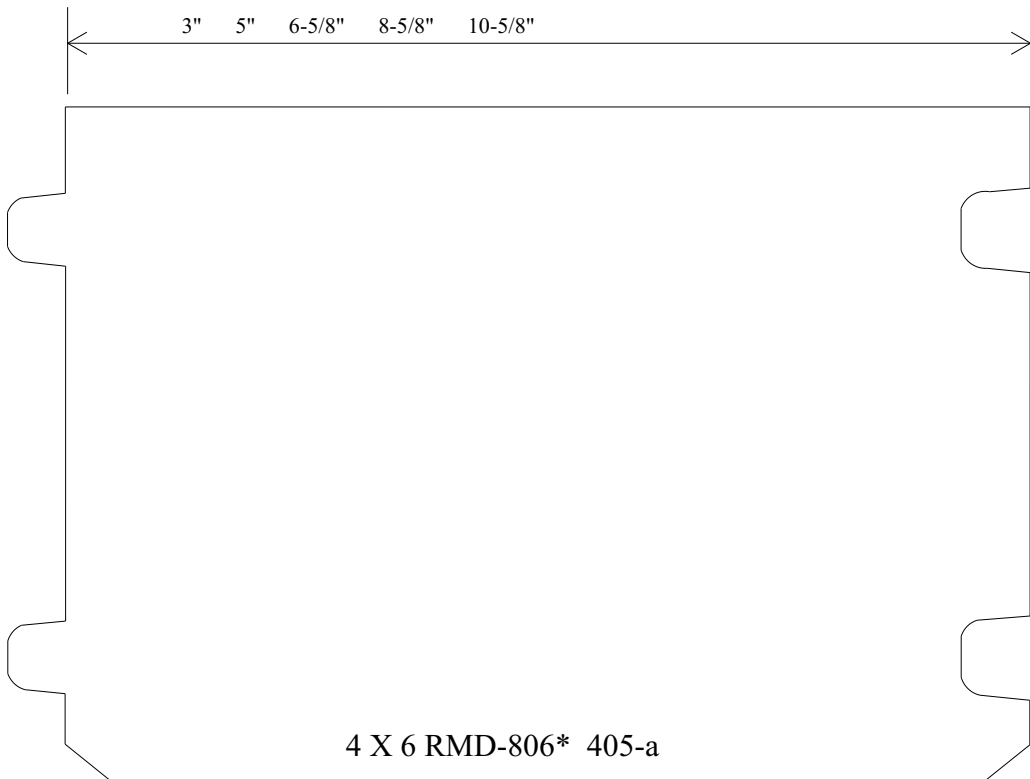
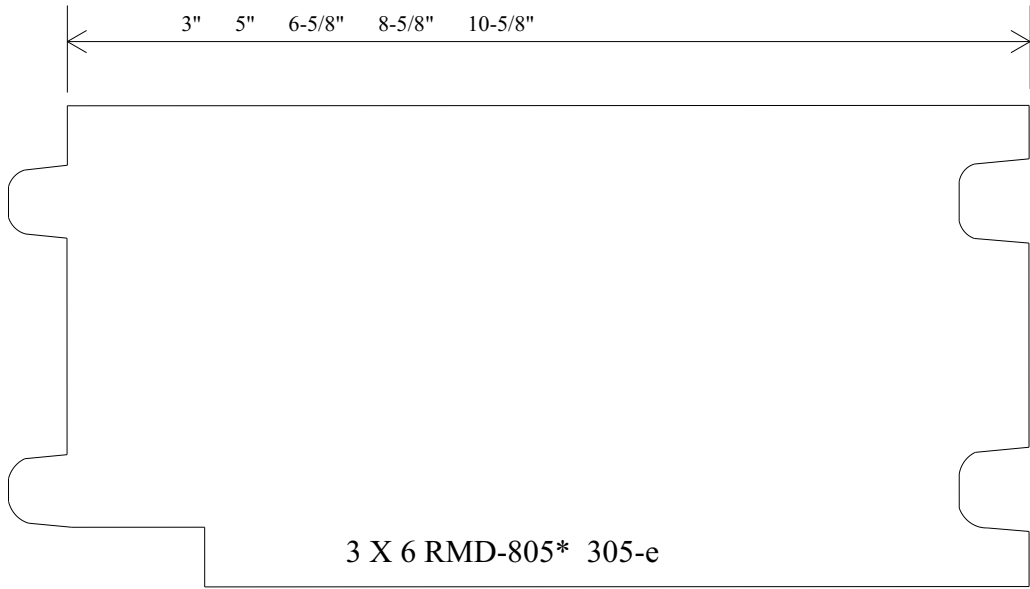

REED MILL & LUMBER CO., INC.

DECKING

